

- Aperture
- Bloom
- Cycle
- Mika
- Moonrise
- Mute
- Scout
- Stella
- Switch
- Tone
- Twin
- Tumbler
- Valco
- Verner

QUICKSHIP →



WageWorks
Tempe, Arizona, USA

Photo Credit: Halifax Digital Image

Distinctive designs, expedited delivery

**Never miss an opportunity because
of a tight timeline. Eureka's extensive
collection of select luminaires
ship in less than 10 days.**



Terms & Conditions

- 10-day lead times are estimated from the date of processing. Does not include weekends/holidays
- All orders received after 4pm EST (1pm PST), on weekends and on holidays, will be processed the next business day
- Incomplete purchase orders will cause delays in order processing and shipment
- A Quickship order must not exceed quantity of 20 per Quickship product
- Same orders or same project can have multiple different Quickship products
- A project can have multiple Quickship orders as long as orders are placed 15 days apart
- Standard shipping terms & conditions apply

The options detailed within the following pages represent product options that qualify for the Quickship program, additional options are available on standard shipping.

For more details, visit eurekalighting.com

**TriHealth Corporate
Administration Offices**
Cincinnati, Ohio, USA

Photo Credit: Ryan C. Kurtz



APERTURE 4256

QUICKSHIP

MAXIMUM 20 UNITS / MAXIMUM 20 UNITÉS

PROJECT PROJET

SPEC TYPE

NOTES



FINISH FINI



WHM



ANTE

FAMILY FAMILLE



4256-12



4256-24



4256-36

4256-12

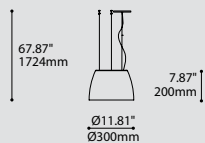

4256-12-RCA

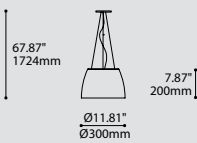

4256-24

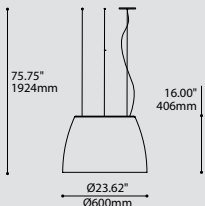

4256-36

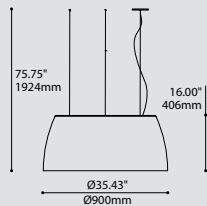

ORDERING SPECIFICATION SPÉCIFICATION DE COMMANDE

CODE

QUICKSHIP

QS

QS QUICKSHIP

MODEL MODÈLE

4256-12 APERTURE 12"
4256-24 APERTURE 24"
4256-36 APERTURE 36"

LIGHT SOURCE SOURCE LUMINEUSE

LED

LED* REGULAR OUTPUT
* 3983 ACCESSORY IS PROVIDED ONLY FOR 4256-12

COLOR TEMPERATURE TEMPÉRATURE DE COULEUR

30 3000K
35 3500K
40 4000K

COLOR RENDERING INDEX (CRI) INDICE DE RENDU DE COULEUR (IRC)

80

80 80+ CRI

VOLTAGE VOLTAGE

120V 120 VOLT
277V 277 VOLT

DIMMING OPTION OPTION DE GRADATION

DV 0-10V DIMMING (120V-277V)
DP PHASE DIMMING (120V ONLY)
LED DIMMING DRIVER IS STANDARD IN THIS PRODUCT. PLEASE SPECIFY YOUR DIMMING TYPE

CABLE CÂBLE

AC

AC AIRCRAFT MOUNTING & CLEAR CABLE, FIELD ADJUSTABLE

CABLE LENGTH LONGUEUR DE CÂBLE

60 60" AIRCRAFT CABLE (STD LENGTH)
** CUSTOM AIRCRAFT CABLE LENGTH (PLEASE SPECIFY)
FOR OVERALL LENGTH, PLEASE CONTACT YOUR EUREKA REPRESENTATIVE

MOUNTING CABLE OPTION OPTION DE MONTAGE DE CÂBLE

RCA* CENTERED ROUND CANOPY - AIRCRAFT CABLES ANGLED TO CENTER
FOR 4256-12 ONLY
IF NO OPTION IS SELECTED, A ROUND CANOPY WITH STRAIGHT AIRCRAFT CABLES WILL BE PROVIDED

CANOPY FINISH FINI PAVILLON

WHM

WHM MATTE WHITE

EXTERIOR SHADE FINISH FINI ABAT-JOUR EXTÉRIEUR

WHM MATTE WHITE
ANTE ANTHRACITE MATTE POLYESTER POWDER COATING

INTERIOR SHADE FINISH FINI ABAT-JOUR INTÉRIEUR

WHM

WHM MATTE WHITE

ACCESSORY ACCESSOIRE

3983 DEEP JUNCTION BOX (PROVIDED FOR 4256-12 AS PER ABOVE)

ADDITIONAL OPTIONS AVAILABLE ON STANDARD SHIPPING / OPTIONS ADDITIONNELLES DISPONIBLES EN LIVRAISON STANDARD

PRODUCT CHARACTERISTICS CARACTÉRISTIQUES DU PRODUIT

BIM DIM EMB IES LED

DESIGN: Hidden inside of an elegant form is a beautiful soft glow of LED illumination that encircles a surprising hollow core. Aperture is available in three formats, small, large and extra-large.

INSTALLATION: Easy to install, adjust and level triple aircraft cable mounting.

LIGHT SOURCE: Aperture features a custom LED light engine that is available with a standard dimming driver.

EXTERIOR FINISH: White or Anthracite matte polyester powder coating.

INTERIOR FINISH: Highly reflective matte white polyester powder coating.

CERTIFIED: c-CSA-us

QUICKSHIP

BLOOM 4269

QUICKSHIP

MAXIMUM 20 UNITS / MAXIMUM 20 UNITÉS

PROJECT PROJET

SPEC TYPE

NOTES



FINISH FINI



BLKE

WHE

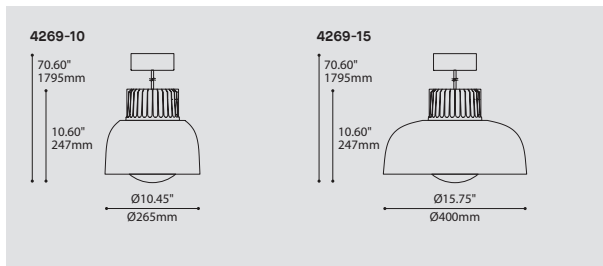

ORDERING SPECIFICATION SPÉCIFICATION DE COMMANDE

CODE

QUICKSHIP

QS

QS QUICKSHIP

MODEL MODÈLE

4269-10 BLOOM 10"
4269-15 BLOOM 15"

LIGHT SOURCE SOURCE LUMINEUSE

LED REGULAR OUTPUT

LED

COLOR TEMPERATURE TEMPÉRATURE DE COULEUR

30 3000K
35 3500K
40 4000K

COLOR RENDERING INDEX (CRI) INDICE DE RENDU DE COULEUR (IRC)

80 80+ CRI

80

VOLTAGE VOLTAGE

120V 120 VOLT
277V 277 VOLT

DIMMING OPTION OPTION DE GRADATION

DV 0-10V DIMMING (120V-277V)
DP PHASE DIMMING (120V ONLY)

LED DIMMING DRIVER IS STANDARD IN THIS PRODUCT, PLEASE SPECIFY YOUR DIMMING TYPE.

CABLE CABLE

C BLACK CABLE, FIELD ADJUSTABLE

C

CABLE LENGTH LONGUEUR DE CABLE

60 60" CABLE (STD LENGTH)
** CUSTOM CABLE LENGTH (PLEASE SPECIFY)
FOR OVERALL LENGTH, PLEASE CONTACT YOUR EUREKA REPRESENTATIVE.

CANOPY FINISH FINI PAVILLON

BLKE BLACK FINE TEXTURE
WHE WHITE FINE TEXTURE

SHADE FINISH FINI ABAT-JOUR (A) (B)

BLKE BLACK FINE TEXTURE
WHE WHITE FINE TEXTURE

(A) SHADE INTERIOR IS ALWAYS WHITE
(B) HEATSINK IS ALWAYS BLACK

DIFFUSER FINISH FINI DIFFUSEUR

WH WHITE

WH

ADDITIONAL OPTIONS AVAILABLE ON STANDARD SHIPPING / OPTIONS ADDITIONNELLES DISPONIBLES EN LIVRAISON STANDARD

PRODUCT CHARACTERISTICS CARACTÉRISTIQUES DU PRODUIT

BIM DIM EMB IES LED

DESIGN:

Bloom is a light fixture with a soft and inviting shape. Under the colorful shade hides a luminous globe offering a generous amount of soft light. Bloom is available in two sizes and a variety of different finishes.

INSTALLATION:

Easy to install and adjust single power cable mounting.

LIGHT SOURCE:

A central powerful COB type light source project a powerful light, softened by the spherical polymer diffuser to create a light that is efficient, yet soft to the eye. Offered with phase or 0-10V gradation options.

STRUCTURE:

High-performance die-cast aluminum heatsink with textured black finish. Spun aluminum shades, offered in a wide variety of external finishes with a white internal finish for optimal light reflection.

CERTIFIED:

c-CSA-us, c-UL-us

QUICKSHIP

BLOOM 4769

QUICKSHIP

MAXIMUM 20 UNITS / MAXIMUM 20 UNITÉS

PROJECT PROJET

SPEC TYPE

NOTES



FINISH FINI



BLKE

WHE

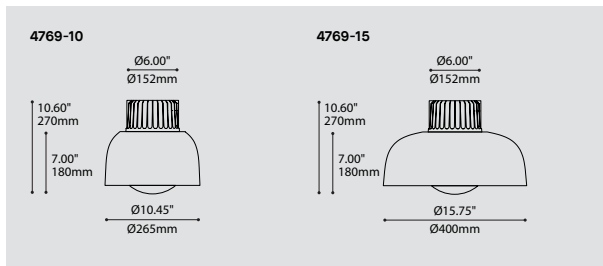

ORDERING SPECIFICATION SPÉCIFICATION DE COMMANDE

CODE

QUICKSHIP

QS

QS QUICKSHIP

MODEL MODÈLE

4769-10 BLOOM 10"
4769-15 BLOOM 15"

LIGHT SOURCE SOURCE LUMINEUSE

LED REGULAR OUTPUT

LED

COLOR TEMPERATURE TEMPÉRATURE DE COULEUR

30 3000K
35 3500K
40 4000K

COLOR RENDERING INDEX (CRI) INDICE DE RENDU DE COULEUR (IRC)

80 80+ CRI

80

VOLTAGE VOLTAGE

120V 120 VOLT
277V 277 VOLT

DIMMING OPTION OPTION DE GRADATION

DV 0-10V DIMMING (120V-277V)
DP PHASE DIMMING (120V ONLY)
LED DIMMING DRIVER IS STANDARD IN THIS PRODUCT, PLEASE SPECIFY YOUR DIMMING TYPE.

HEATSINK FINISH FINI RADIATEUR

BLKE BLACK FINE TEXTURE

BLKE

SHADE FINISH FINI ABAT-JOUR (A)

BLKE BLACK FINE TEXTURE
WHE WHITE FINE TEXTURE
(A) SHADE INTERIOR IS ALWAYS WHITE

DIFFUSER FINISH FINI DIFFUSEUR

WH WHITE

WH

ACCESSORY ACCESSOIRE

3983 DEEP JUNCTION BOX

3983

ADDITIONAL OPTIONS AVAILABLE ON STANDARD SHIPPING / OPTIONS ADDITIONNELLES DISPONIBLES EN LIVRAISON STANDARD

PRODUCT CHARACTERISTICS CARACTÉRISTIQUES DU PRODUIT

BIM DIM EMB IES LED

- DESIGN:** Bloom is a light fixture with a soft and inviting shape. Under the colorful shade hides a luminous globe offering a generous amount of soft light. Bloom is available in two sizes and a variety of different finishes.
- INSTALLATION:** Ceiling installation on deep junction box (supplied with light fixture).
- LIGHT SOURCE:** A central powerful COB type light source project a powerful light, softened by the spherical polymer diffuser to create a light that is efficient, yet soft to the eye. Offered with phase or 0-10V gradation options.
- STRUCTURE:** High-performance die-cast aluminum heatsink with textured black finish. Spun aluminum shades, offered in a wide variety of external finishes with a white internal finish for optimal light reflection.
- CERTIFIED:** c-CSA-us, c-UL-us

QUICKSHIP

BLOOM 1209

QUICKSHIP

MAXIMUM 20 UNITS / MAXIMUM 20 UNITÉS

PROJECT PROJET

SPEC TYPE

NOTES



FINISH FINI



BLKE

WHE

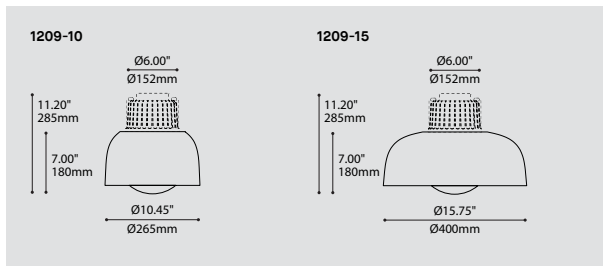

ORDERING SPECIFICATION SPÉCIFICATION DE COMMANDE

CODE

QUICKSHIP

QS

QS QUICKSHIP

MODEL MODÈLE

1209-10 BLOOM 10"
 1209-15 BLOOM 15"
 1209-10-IC BLOOM 10" (INSULATED CEILING)
 1209-15-IC BLOOM 15" (INSULATED CEILING)

LIGHT SOURCE SOURCE LUMINEUSE

LED

LED REGULAR OUTPUT

COLOR TEMPERATURE TEMPÉRATURE DE COULEUR

30 3000K
 35 3500K
 40 4000K

COLOR RENDERING INDEX (CRI) INDICE DE RENDU DE COULEUR (IRC)

80

80 80+ CRI

VOLTAGE VOLTAGE

120V 120 VOLT
 277V 277 VOLT

DIMMING OPTION OPTION DE GRADATION

DV 0-10V DIMMING (120V-277V)
 DP PHASE DIMMING (120V ONLY)

LED DIMMING DRIVER IS STANDARD IN THIS PRODUCT, PLEASE SPECIFY YOUR DIMMING TYPE.

SHADE FINISH FINI ABAT-JOUR (A)

BLKE BLACK FINE TEXTURE
 WHE WHITE FINE TEXTURE

(A) SHADE INTERIOR IS ALWAYS WHITE

DIFFUSER FINISH FINI DIFFUSEUR

WH

WH WHITE

ADDITIONAL OPTIONS AVAILABLE ON STANDARD SHIPPING / OPTIONS ADDITIONNELLES DISPONIBLES EN LIVRAISON STANDARD

PRODUCT CHARACTERISTICS CARACTÉRISTIQUES DU PRODUIT



DESIGN:

Bloom is a light fixture with a soft and inviting shape. Under the colorful shade hides a luminous globe offering a generous amount of soft light. Bloom is available in two sizes and a variety of different finishes.

INSTALLATION:

Recessed mounting system allows for simple and secure installation in a variety of ceiling types from 0.375" (9.5mm) to 2.75" (70mm) thick, accommodating renovation projects.

LIGHT SOURCE:

A central powerful COB type light source project a powerful light, softened by the spherical polymer diffuser to create a light that is efficient, yet soft to the eye. Offered with phase or 0-10V gradation options.

STRUCTURE:

High-performance die-cast aluminum heatsink with textured black finish. Spun aluminum shades, offered in a wide variety of external finishes with a white internal finish for optimal light reflection.

CERTIFIED:

c-CSA-us

CYCLE 4800-24

QUICKSHIP

MAXIMUM 20 UNITS / MAXIMUM 20 UNITÉS

PROJECT PROJET

SPEC TYPE

NOTES





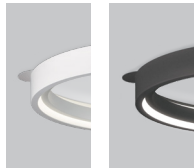



FINISH FINI

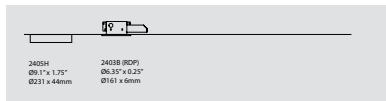

WHM-WH ANTE-WH

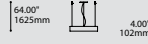
MOUNTING OPTIONS OPTIONS DE MONTAGE



| 4800-24 | 4800-24-RCA | 4800-24-RCC |
|---|--|--|
|  <p>64.00" 1625mm 4.00" 102mm</p> |  <p>64.00" 1625mm 4.00" 102mm</p> |  <p>64.00" 1625mm 4.00" 102mm</p> |
|  <p>Ø23.30" Ø592mm</p> |  <p>Ø23.30" Ø592mm</p> |  <p>Ø23.30" Ø592mm</p> |

ORDERING SPECIFICATION SPÉCIFICATION DE COMMANDE

CODE

QUICKSHIP

QS

QS QUICKSHIP

MODEL MODÈLE

4800-24

4800-24 CYCLE 24"

LIGHT SOURCE SOURCE LUMINEUSE

LED REGULAR OUTPUT

LED.HO HIGH OUTPUT

LED.SHO SUPER HIGH OUTPUT

COLOR TEMPERATURE TEMPÉRATURE DE COULEUR

30 3000K

35 3500K

40 4000K

COLOR RENDERING INDEX (CRI) INDICE DE RENDU DE COULEUR (IRC)

80

80 80+ CRI

VOLTAGE VOLTAGE

120V 120 VOLT

277V 277 VOLT

DIMMING OPTION OPTION DE GRADATION

DV 0-10V DIMMING (120V-277V)

DP PHASE DIMMING (120V ONLY)

LED DIMMING DRIVER IS STANDARD IN THIS PRODUCT, PLEASE SPECIFY YOUR DIMMING TYPE

DRIVER POSITION POSITION DU PILOTE

RDP* RECESSED DRIVER

* ONLY AVAILABLE WITH 120V & 277V

* 3981C ACCESSORY IS REQUIRED

CABLE CÂBLE

AC

AC AIRCRAFT MOUNTING & CLEAR CABLE, FIELD ADJUSTABLE

CABLE LENGTH LONGUEUR DE CÂBLE

60 60" AIRCRAFT CABLE (STD LENGTH)

** CUSTOM AIRCRAFT CABLE LENGTH (PLEASE SPECIFY)

FOR OVERALL LENGTH, PLEASE CONTACT YOUR EUREKA REPRESENTATIVE

MOUNTING OPTION OPTION DE MONTAGE

RC

RC ROUND CANOPY / PAVILLON ROND

FOR RECESSED DRIVER OPTION: 0.25" (2403B)

FOR STANDARD: 1.75" CANOPY (2405H)

MOUNTING CABLE OPTION OPTION DE MONTAGE DE CÂBLE

RCA* CENTERED ROUND CANOPY – AIRCRAFT CABLES ANGLED TO CENTER

RCC CENTERED ROUND CANOPY – STRAIGHT AIRCRAFT CABLES

* NOT AVAILABLE WITH RECESSED DRIVER (RDP)

IF NO OPTION IS SELECTED, AN OFF-CENTERED ROUND CANOPY WITH STRAIGHT AIRCRAFT CABLES IS STANDARD

CANOPY FINISH FINI PAVILLON

WHM

WHM MATTE WHITE

RING FINISH FINI ANNEAU

WHM MATTE WHITE

ANTE ANTHRACITE FINE TEXTURE

ACCESSORY ACCESSOIRE

3981C JUNCTION BOX FOR RECESSED DRIVER OPTION

2990I-24 TONE INTERIOR CHARCOAL FELT

2990E-24 TONE EXTERIOR CHARCOAL FELT

2990EI-24 TONE EXTERIOR-INTERIOR CHARCOAL FELT

ADDITIONAL OPTIONS AVAILABLE ON STANDARD SHIPPING / OPTIONS ADDITIONNELLES DISPONIBLES EN LIVRAISON STANDARD

QUICKSHIP

CYCLE 4800-36

QUICKSHIP

MAXIMUM 20 UNITS / MAXIMUM 20 UNITÉS

PROJECT PROJET

SPEC TYPE

NOTES



FINISH FINI

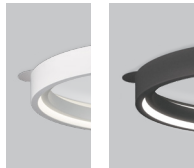

WHM-WH ANTE-WH

MOUNTING OPTIONS OPTIONS DE MONTAGE

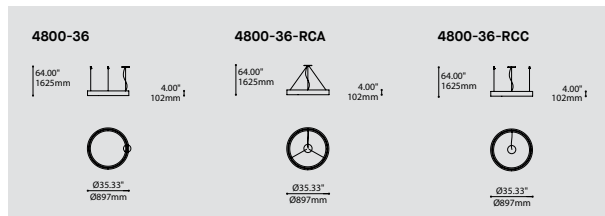
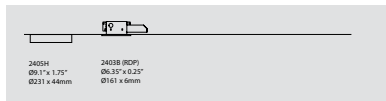

ORDERING SPECIFICATION SPÉCIFICATION DE COMMANDE

CODE

QUICKSHIP

QS

QS QUICKSHIP

MODEL MODÈLE

4800-36

4800-36 CYCLE 36"

LIGHT SOURCE SOURCE LUMINEUSE

LED REGULAR OUTPUT

LED.HO HIGH OUTPUT

LED.SHO SUPER HIGH OUTPUT

COLOR TEMPERATURE TEMPÉRATURE DE COULEUR

30 3000K

35 3500K

40 4000K

COLOR RENDERING INDEX (CRI) INDICE DE RENDU DE COULEUR (IRC)

80

80 80+ CRI

VOLTAGE VOLTAGE

120V 120 VOLT

277V 277 VOLT

DIMMING OPTION OPTION DE GRADATION

DV 0-10V DIMMING (120V-277V)

DP PHASE DIMMING (120V ONLY)

LED DIMMING DRIVER IS STANDARD IN THIS PRODUCT, PLEASE SPECIFY YOUR DIMMING TYPE

DRIVER POSITION POSITION DU PILOTE

RDP* RECESSED DRIVER

* ONLY AVAILABLE WITH 120V & 277V

* 3981C ACCESSORY IS REQUIRED

CABLE CÂBLE

AC

AC AIRCRAFT MOUNTING & CLEAR CABLE, FIELD ADJUSTABLE

CABLE LENGTH LONGUEUR DE CÂBLE

60 60" AIRCRAFT CABLE (STD LENGTH)

** CUSTOM AIRCRAFT CABLE LENGTH (PLEASE SPECIFY)

FOR OVERALL LENGTH, PLEASE CONTACT YOUR EUREKA REPRESENTATIVE

MOUNTING OPTION OPTION DE MONTAGE

RC

RC ROUND CANOPY / PAVILLON ROND

FOR RECESSED DRIVER OPTION: 0.25" (2403B)

FOR STANDARD: 1.75" CANOPY (2405H)

MOUNTING CABLE OPTION OPTION DE MONTAGE DE CÂBLE

RCA* CENTERED ROUND CANOPY - AIRCRAFT CABLES ANGLED TO CENTER

RCC CENTERED ROUND CANOPY - STRAIGHT AIRCRAFT CABLES

* NOT AVAILABLE WITH RECESSED DRIVER (RDP)

IF NO OPTION IS SELECTED, AN OFF-CENTERED ROUND CANOPY WITH STRAIGHT AIRCRAFT CABLES IS STANDARD

CANOPY FINISH FINI PAVILLON

WHM

WHM MATTE WHITE

RING FINISH FINI ANNEAU

WHM MATTE WHITE

ANTE ANTHRACITE FINE TEXTURE

ACCESSORY ACCESSOIRE

3981C JUNCTION BOX FOR RECESSED DRIVER OPTION

2990I-36 TONE INTERIOR CHARCOAL FELT

2990E-36 TONE EXTERIOR CHARCOAL FELT

2990EI-36 TONE EXTERIOR-INTERIOR CHARCOAL FELT

ADDITIONAL OPTIONS AVAILABLE ON STANDARD SHIPPING / OPTIONS ADDITIONNELLES DISPONIBLES EN LIVRAISON STANDARD

QUICKSHIP

CYCLE 4800-54

QUICKSHIP

MAXIMUM 20 UNITS / MAXIMUM 20 UNITÉS

PROJECT PROJET

SPEC TYPE

NOTES



FINISH FINI

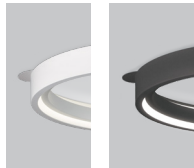

WHM-WH ANTE-WH

MOUNTING OPTIONS OPTIONS DE MONTAGE

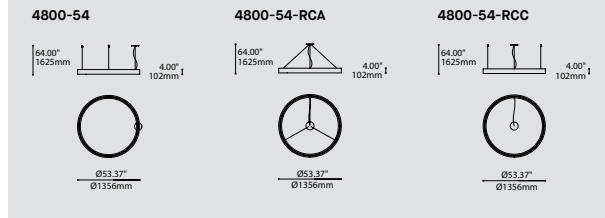
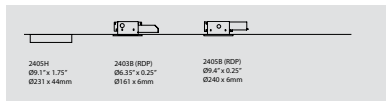

ORDERING SPECIFICATION SPÉCIFICATION DE COMMANDE

CODE

QUICKSHIP

QS

QS QUICKSHIP

MODEL MODÈLE

4800-54

4800-54 CYCLE 54*

LIGHT SOURCE SOURCE LUMINEUSE

LED REGULAR OUTPUT

LED.HO HIGH OUTPUT

LED.SHO SUPER HIGH OUTPUT

COLOR TEMPERATURE TEMPÉRATURE DE COULEUR

30 3000K

35 3500K

40 4000K

COLOR RENDERING INDEX (CRI) INDICE DE RENDU DE COULEUR (IRC)

80

80 80+ CRI

VOLTAGE VOLTAGE

120V 120 VOLT

277V 277 VOLT

DIMMING OPTION OPTION DE GRADATION

DV 0-10V DIMMING (120V-277V)

DP PHASE DIMMING (120V ONLY)

LED DIMMING DRIVER IS STANDARD IN THIS PRODUCT, PLEASE SPECIFY YOUR DIMMING TYPE

DRIVER POSITION POSITION DU PILOTE

RDP* RECESSED DRIVER

* ONLY AVAILABLE WITH 120V & 277V

* 3981C (REG) OR 3981D (HO) ACCESSORY IS REQUIRED

CABLE CÂBLE

AC

AC AIRCRAFT MOUNTING & CLEAR CABLE, FIELD ADJUSTABLE

CABLE LENGTH LONGUEUR DE CÂBLE

60 60" AIRCRAFT CABLE (STD LENGTH)

** CUSTOM AIRCRAFT CABLE LENGTH (PLEASE SPECIFY)

FOR OVERALL LENGTH, PLEASE CONTACT YOUR EUREKA REPRESENTATIVE

MOUNTING OPTION OPTION DE MONTAGE

RC

RC ROUND CANOPY / PAVILLON ROND

FOR RECESSED DRIVER OPTION (REG): 0.25" (2403B)

FOR RECESSED DRIVER OPTION (HO): 0.25" (2405B)

FOR STANDARD: 1.75" CANOPY (2405H)

MOUNTING CABLE OPTION OPTION DE MONTAGE DE CÂBLE

RCA* CENTERED ROUND CANOPY - AIRCRAFT CABLES ANGLED TO CENTER

RCC CENTERED ROUND CANOPY - STRAIGHT AIRCRAFT CABLES

* NOT AVAILABLE WITH RECESSED DRIVER (RDP)

IF NO OPTION IS SELECTED, AN OFF-CENTERED ROUND CANOPY WITH STRAIGHT AIRCRAFT CABLES IS STANDARD

CANOPY FINISH FINI PAVILLON

WHM

WHM MATTE WHITE

RING FINISH FINI ANNEAU

WHM MATTE WHITE

ANTE ANTHRACITE FINE TEXTURE

ACCESSORY ACCESSOIRE

3981C JUNCTION BOX FOR RECESSED DRIVER OPTION (REG)

3981D JUNCTION BOX FOR RECESSED DRIVER OPTION (HO)

2990I-54 TONE INTERIOR CHARCOAL FELT

2990E-54 TONE EXTERIOR CHARCOAL FELT

2990EI-54 TONE EXTERIOR-INTERIOR CHARCOAL FELT

ADDITIONAL OPTIONS AVAILABLE ON STANDARD SHIPPING / OPTIONS ADDITIONNELLES DISPONIBLES EN LIVRAISON STANDARD

QUICKSHIP

Dot Foods
Mt. Sterling, Illinois, USA

Photo Credit: Ben Romang



2000
Expansion into Retail
40th Anniversary Employee Gift
SALES: \$1 billion
2,000 employees
Dot Enters Non-Foods Category

2002
Dot acquires Blue Oyster Bar Corporation in Liverpool, NY
Convenience Store Channel Expansion

2005
DC opens in Ardmore, OK
SALES: \$2 billion
3,900 employees

2007
DC opens in Cambridge City, IN
Robert Tracy 1924-2006
President Joe Tracy and CEO John Tracy

2008
DC opens in Burley, ID
SALES: \$3 billion
3,600 employees
Mt. Sterling YMC is Donated by Dot, RTI and RT and Dorothy

2009
Dot Expands into Drug Channel
Dot Expands into Mass Channel

2011
Dot forms an import company, Savor Imports
SALES: \$4 billion
3,900 employees

2013
Dot opens its first Family Health Center in Vidalia, GA
The Country Store, Renamed Dorothy's Market, is Moved into a New Building in Uptown Mt. Sterling

2014
SALES: \$5 billion
4,600 employees
Dot adds an International Sales Division
Dot Foods' 80th Anniversary Joint Venture

MIKA 4230-RAP

QUICKSHIP

MAXIMUM 20 UNITS / MAXIMUM 20 UNITÉS

PROJECT PROJET

SPEC TYPE

NOTES



OVERALL HEIGHT HAUTEUR HORS TOUT

| | |
|--------------|---------|
| LIGHT SOURCE | LED DIM |
| MOUNTING | 2403G |
| CABLE | 76.87" |

MOUNTING OPTIONS OPTIONS DE MONTAGE

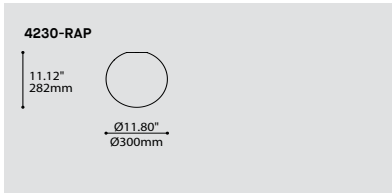
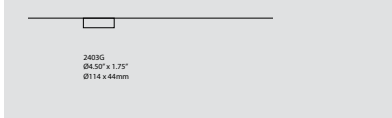

ORDERING SPECIFICATION SPÉCIFICATION DE COMMANDE

CODE

QUICKSHIP

QS

QS QUICKSHIP

MODEL MODÈLE

4230-RAP

4230-RAP MIKA RAP (12")

LIGHT SOURCE SOURCE LUMINEUSE

LED.9

LED.9 9W, LED

COLOR TEMPERATURE TEMPÉRATURE DE COULEUR (A)

30 3000K

35 3500K

40 4000K

COLOR RENDERING INDEX (CRI) INDICE DE RENDU DE COULEUR (IRC)

80

80 80+ CRI

VOLTAGE VOLTAGE

120V 120 VOLT

277V 277 VOLT

DIMMING OPTION OPTION DE GRADATION

DV 0-10V DIMMING (120V-277V)

DP PHASE DIMMING (120V ONLY)

LED DIMMING DRIVER IS STANDARD IN THIS PRODUCT. PLEASE SPECIFY YOUR DIMMING TYPE

CABLE CÂBLE

C

C CLEAR CABLE, FIELD ADJUSTABLE

CABLE LENGTH LONGUEUR DE CÂBLE

60 60" CABLE (STD LENGTH)

** CUSTOM CABLE LENGTH (PLEASE SPECIFY)

FOR OVERALL LENGTH, PLEASE CONTACT YOUR EUREKA REPRESENTATIVE

MOUNTING MONTAGE

RC

RC ROUND CANOPY / PAVILLON ROND

FOR DIMMING LED: 1.75" CANOPY (2403G)

STRUCTURE FINISH FINI STRUCTURE

WHE

WHE WHITE FINE TEXTURE

DIFFUSER FINISH FINI DIFFUSEUR

WH

WH WHITE

ADDITIONAL OPTIONS AVAILABLE ON STANDARD SHIPPING / OPTIONS ADDITIONNELLES DISPONIBLES EN LIVRAISON STANDARD

PRODUCT CHARACTERISTICS CARACTÉRISTIQUES DU PRODUIT

BIM **DIM** **EMB** **IES** **LED**

DESIGN:

Classic round globe with a high-tech frosted shade and LED light engine, Mika can be specified as a single pendant or create a bouquet to fill large spaces with a soft and diffused light.

LIGHT SOURCE:

High performance LED module with dimming options available.

STRUCTURE:

Die-cast aluminum with black satin anodized finish with a textured white finish top canopy.

DIFFUSER:

Impact and graffiti resistant, translucent white rotomolded MDPE is the perfect material for this spherical design.

CERTIFIED:

c-CSA-us

MIKA 4230-RAQ

QUICKSHIP

MAXIMUM 20 UNITS / MAXIMUM 20 UNITÉS

PROJECT PROJET

SPEC TYPE

NOTES



OVERALL HEIGHT HAUTEUR HORS TOUT

| | |
|--------------|---------|
| LIGHT SOURCE | LED DIM |
| MOUNTING | 2403G |
| CABLE | 76.87" |

MOUNTING OPTIONS OPTIONS DE MONTAGE

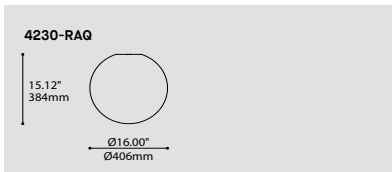
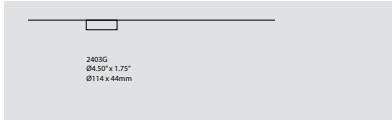

ORDERING SPECIFICATION SPÉCIFICATION DE COMMANDE

CODE

QUICKSHIP

QS

QS QUICKSHIP

MODEL MODÈLE

4230-RAQ

4230-RAQ MIKA RAP (16")

LIGHT SOURCE SOURCE LUMINEUSE

LED.13

LED.13 13W, LED

COLOR TEMPERATURE TEMPÉRATURE DE COULEUR (A)

30 3000K
35 3500K
40 4000K

COLOR RENDERING INDEX (CRI) INDICE DE RENDU DE COULEUR (IRC)

80

80 80+ CRI

VOLTAGE VOLTAGE

120V 120 VOLT
277V 277 VOLT

DIMMING OPTION OPTION DE GRADATION

DV 0-10V DIMMING (120V-277V)
DP PHASE DIMMING (120V ONLY)
LED DIMMING DRIVER IS STANDARD IN THIS PRODUCT. PLEASE SPECIFY YOUR DIMMING TYPE

CABLE CÂBLE

C

C CLEAR CABLE, FIELD ADJUSTABLE

CABLE LENGTH LONGUEUR DE CÂBLE

60 60" CABLE (STD LENGTH)
** CUSTOM CABLE LENGTH (PLEASE SPECIFY)
FOR OVERALL LENGTH, PLEASE CONTACT YOUR EUREKA REPRESENTATIVE

MOUNTING MONTAGE

RC

RC ROUND CANOPY / PAVILLON ROND
FOR DIMMING LED: 1.75" CANOPY (2403G)

STRUCTURE FINISH FINI STRUCTURE

WHE

WHE WHITE FINE TEXTURE

DIFFUSER FINISH FINI DIFFUSEUR

WH

WH WHITE

ADDITIONAL OPTIONS AVAILABLE ON STANDARD SHIPPING / OPTIONS ADDITIONNELLES DISPONIBLES EN LIVRAISON STANDARD

PRODUCT CHARACTERISTICS CARACTÉRISTIQUES DU PRODUIT

BIM **DIM** **EMB** **IES** **LED**

DESIGN: Classic round globe with a high-tech frosted shade and LED light engine, Mika can be specified as a single pendant or create a bouquet to fill large spaces with a soft and diffused light.

LIGHT SOURCE: High performance LED module with dimming options available.

STRUCTURE: Die-cast aluminum with black satin anodized finish with a textured white finish top canopy.

DIFFUSER: Impact and graffiti resistant, translucent white rotomolded MDPE is the perfect material for this spherical design.

CERTIFIED: c-CSA-us

MOONRISE CLASSIC 3530-23

QUICKSHIP

MAXIMUM 20 UNITS / MAXIMUM 20 UNITÉS

PROJECT PROJET

SPEC TYPE

NOTES



3530-23

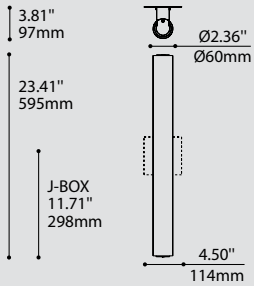

ORDERING SPECIFICATION SPÉCIFICATION DE COMMANDE

CODE

QUICKSHIP

QS

QS QUICKSHIP

MODEL MODÈLE

3530-23

3530-23 MOONRISE CLASSIC 23" (ROUND GLASS)

LIGHT SOURCE SOURCE LUMINEUSE

LED REGULAR OUTPUT
LED.HO HIGH OUTPUT

COLOR TEMPERATURE TEMPÉRATURE DE COULEUR (A)

30 3000K
35 3500K
40 4000K

VOLTAGE VOLTAGE

120V 120 VOLT
277V 277 VOLT

DIMMING OPTION OPTION DE GRADATION

DV 0-10V DIMMING (120V-277V)

STRUCTURE FINISH FINI STRUCTURE

CHR CHROME
SC SATIN CHROME

DIFFUSER FINISH FINI DIFFUSEUR

WH

WH WHITE

ACCESSORY ACCESSOIRE

3980 MINI JUNCTION BOX

ADDITIONAL OPTIONS AVAILABLE ON STANDARD SHIPPING / OPTIONS ADDITIONNELLES DISPONIBLES EN LIVRAISON STANDARD

PRODUCT CHARACTERISTICS CARACTÉRISTIQUES DU PRODUIT



- DESIGN:** Modern classic round profile wall sconce or surface mounted fixture. ADA compliant.
- STRUCTURE:** Machined steel end caps & die-stamped steel structure with plated finish.
- DIFFUSER:** Hand blown white triplex glass.
- CERTIFIED:** c-CSA-us, c-UL-us
- CONCEPTION:** Applique ou plafonnier cylindrique classique et contemporain. Conforme à la norme ADA.
- STRUCTURE:** Embout d'acier usiné et acier embouti plaqués.
- ABAT-JOUR:** Verre triplex blanc soufflé à la main.
- CERTIFIÉ:** c-CSA-us, c-UL-us

MUTE 4258-16

QUICKSHIP

MAXIMUM 20 UNITS / MAXIMUM 20 UNITÉS

PROJECT PROJET

SPEC TYPE

NOTES



FINISH FINI



CHF

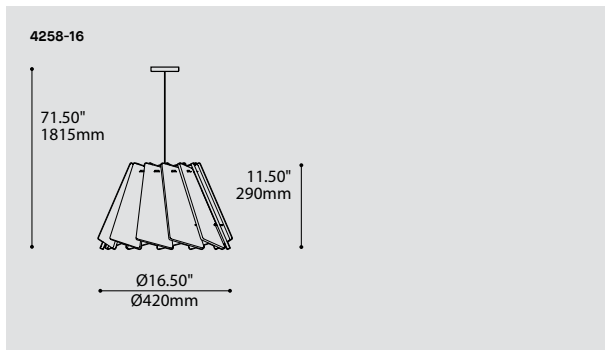

ORDERING SPECIFICATION SPÉCIFICATION DE COMMANDE

CODE

QUICKSHIP

QS

QS QUICKSHIP

MODEL MODÈLE

4258-16

4258-16 MUTE 16"

LIGHT SOURCE SOURCE LUMINEUSE

LED

LED REGULAR OUTPUT

COLOR TEMPERATURE TEMPÉRATURE DE COULEUR

30 3000K

35 3500K

40 4000K

COLOR RENDERING INDEX (CRI) INDICE DE RENDU DE COULEUR (IRC)

80

80 80+ CRI

VOLTAGE VOLTAGE

120V 120 VOLT

277V 277 VOLT

DIMMING OPTION OPTION DE GRADATION

DV 0-10V DIMMING (120V-277V)

DP PHASE DIMMING (120V ONLY)

LED DIMMING DRIVER IS STANDARD IN THIS PRODUCT. PLEASE SPECIFY YOUR DIMMING TYPE

CABLE CÂBLE

C

C CLEAR CABLE, FIELD ADJUSTABLE

CABLE LENGTH LONGUEUR DE CÂBLE

60 60" CABLE (STD LENGTH)

** CUSTOM CABLE LENGTH (PLEASE SPECIFY)

FOR OVERALL LENGTH, PLEASE CONTACT YOUR EUREKA REPRESENTATIVE

CANOPY FINISH FINI PAVILLON

WHE

WHE WHITE FINE TEXTURE

SHADE FINISH FINI ABAT-JOUR

CHF

CHF CHARCOAL FELT

ACRYLIC FINISH FINI ACRYLIQUE

WH

WH WHITE

ADDITIONAL OPTIONS AVAILABLE ON STANDARD SHIPPING / OPTIONS ADDITIONNELLES DISPONIBLES EN LIVRAISON STANDARD

PRODUCT CHARACTERISTICS CARACTÉRISTIQUES DU PRODUIT



DESIGN:

Now offered in two formats, this soft, colorful and sound absorbing large format downlight pendant is composed of twelve felt-like acoustic panels surrounding a custom LED light source distributing a uniform and direct light.

INSTALLATION:

Easy to install, adjust single power cable mounting with clip-on acoustic panels.

LIGHT SOURCE:

Mute features a custom LED light engine supplied with a standard dimming driver (0-10V or phase).

STRUCTURE:

Precision cut chrome top cover plate and white or chrome canopy.

SHADE:

The custom CNC cut panels are made from recycled PET bottles and are recyclable. Available in charcoal.

CERTIFIED:

c-CSA-us

MUTE 4258-32

QUICKSHIP

MAXIMUM 20 UNITS / MAXIMUM 20 UNITÉS

PROJECT PROJET

SPEC TYPE

NOTES



FINISH FINI



CHF

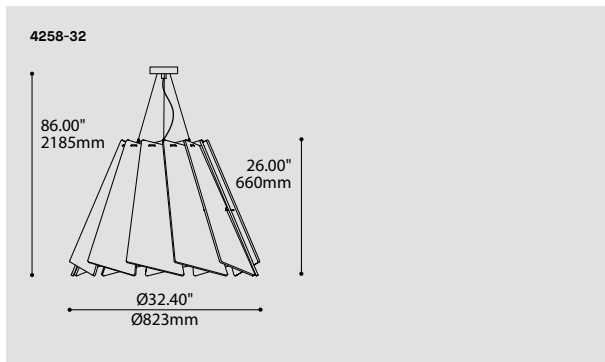

ORDERING SPECIFICATION SPÉCIFICATION DE COMMANDE

CODE

QUICKSHIP

QS

QS QUICKSHIP

MODEL MODÈLE

4258-32

4258-32 MUTE 32"

LIGHT SOURCE SOURCE LUMINEUSE

LED

LED REGULAR OUTPUT

COLOR TEMPERATURE TEMPÉRATURE DE COULEUR

30 3000K

35 3500K

40 4000K

COLOR RENDERING INDEX (CRI) INDICE DE RENDU DE COULEUR (IRC)

80

80 80+ CRI

VOLTAGE VOLTAGE

120V 120 VOLT

277V 277 VOLT

DIMMING OPTION OPTION DE GRADATION

DV 0-10V DIMMING (120V-277V)

DP PHASE DIMMING (120V ONLY)

LED DIMMING DRIVER IS STANDARD IN THIS PRODUCT. PLEASE SPECIFY YOUR DIMMING TYPE

CABLE CÂBLE

AC

AC AIRCRAFT MOUNTING & CLEAR CABLE, FIELD ADJUSTABLE

CABLE LENGTH LONGUEUR DE CÂBLE

60 60" AIRCRAFT CABLE (STD LENGTH)

** CUSTOM AIRCRAFT CABLE LENGTH (PLEASE SPECIFY)

FOR OVERALL LENGTH, PLEASE CONTACT YOUR EUREKA REPRESENTATIVE

CANOPY FINISH FINI PAVILLON

WHE

WHE WHITE FINE TEXTURE

SHADE FINISH FINI ABAT-JOUR

CHF

CHF CHARCOAL FELT

ACRYLIC FINISH FINI ACRYLIQUE

WH

WH WHITE

ADDITIONAL OPTIONS AVAILABLE ON STANDARD SHIPPING / OPTIONS ADDITIONNELLES DISPONIBLES EN LIVRAISON STANDARD

PRODUCT CHARACTERISTICS CARACTÉRISTIQUES DU PRODUIT



DESIGN:

Now offered in two formats, this soft, colorful and sound absorbing large format downlight pendant is composed of twelve felt-like acoustic panels surrounding a custom LED light source distributing a uniform and direct light.

INSTALLATION:

Easy to install, adjust and level triple aircraft cable mounting with clip-on acoustic panels.

LIGHT SOURCE:

Mute features a custom LED light engine supplied with a standard dimming driver (0-10V or phase).

STRUCTURE:

Precision cut chrome top cover plate and white or chrome canopy.

SHADE:

The custom CNC cut panels are made from recycled PET bottles and are recyclable. Available in charcoal.

CERTIFIED:

c-CSA-us

Confidential Client
Québec City, Québec, CA

Photo Credit: Stephane Groleau



106
Salle de
réunion

SCOUT 4048

QUICKSHIP

MAXIMUM 20 UNITS / MAXIMUM 20 UNITÉS

PROJECT PROJET

SPEC TYPE

NOTES



FINISH FINI



BLKE

WHE

OVERALL HEIGHT HAUTEUR HORS TOUT

| | LED 0.50" CANOPY |
|-----------------|---------------------|
| MOUNTING | 2471C |
| CABLE & 4048-6 | 69.70" |
| CABLE & 4048-10 | 73.95" |
| CABLE & 4048-18 | 81.45" |

MOUNTING OPTIONS OPTIONS DE MONTAGE



STEM OR CABLE OPTION OPTIONS DE TIGE OU CABLE

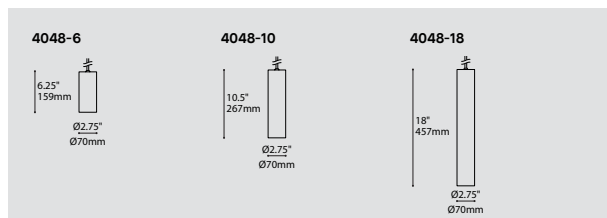
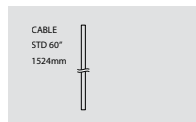

ORDERING SPECIFICATION SPÉCIFICATION DE COMMANDE

CODE

QUICKSHIP

QS

QS QUICKSHIP

MODEL MODÈLE

4048-6 SCOUT 6"
4048-10 SCOUT 10"
4048-18 SCOUT 18"

LIGHT SOURCE SOURCE LUMINEUSE

LED REGULAR OUTPUT
LED.HO HIGH OUTPUT

COLOR TEMPERATURE TEMPÉRATURE DE COULEUR

30 3000K
35 3500K
40 4000K

COLOR RENDERING INDEX (CRI) INDICE DE RENDU DE COULEUR (IRC)

80 80+ CRI

80

VOLTAGE VOLTAGE

120V 120 VOLT
277V 277 VOLT

DIMMING OPTION OPTION DE GRADATION

DV 0-10V DIMMING (120V-277V)
DP PHASE DIMMING (120V ONLY)
LED DIMMING DRIVER IS STANDARD IN THIS PRODUCT. PLEASE SPECIFY YOUR DIMMING TYPE

BEAM ANGLE ANGLE DE FAISCEAU

NA NARROW (24°)
ME MEDIUM (45°)

OPTICAL ACCESSORIES ACCESSOIRES OPTIQUES

CLR CLEAR GLASS LENS
FRO FROSTED GLASS LENS
HON HONEYCOMB LOUVER
SOL SOLITE SOFTENING LENS

CABLE CABLE

C

C* BLACK OR WHITE CABLE, FIELD ADJUSTABLE

*FOR WHITE STRUCTURE: WHITE CABLE, FOR OTHER STRUCTURE FINISH: BLACK CABLE

CABLE LENGTH LONGUEUR DE CABLE

60 60" CABLE (STD LENGTH)
** CUSTOM CABLE LENGTH (PLEASE SPECIFY)
FOR OVERALL LENGTH, PLEASE CONTACT YOUR EUREKA REPRESENTATIVE

MOUNTING MONTAGE

RC

RC ROUND CANOPY / PAVILLON ROND
SCREWLESS 0,5" CANOPY (2471C)

CANOPY FINISH FINI PAVILLON

BLKE BLACK FINE TEXTURE
WHE WHITE FINE TEXTURE

STRUCTURE FINISH FINI STRUCTURE

BLKE BLACK FINE TEXTURE
WHE WHITE FINE TEXTURE

BAFFLE FINISH FINI DÉFLECTEUR

BLKE BLACK FINE TEXTURE
WHE WHITE FINE TEXTURE

ACCESSORY ACCESSOIRE

3983 DEEP JUNCTION BOX (PROVIDED FOR 4048-6 WITH CANOPY)

ADDITIONAL OPTIONS AVAILABLE ON STANDARD SHIPPING / OPTIONS ADDITIONNELLES DISPONIBLES EN LIVRAISON STANDARD

QUICKSHIP

SCOUT 4049

QUICKSHIP

MAXIMUM 20 UNITS / MAXIMUM 20 UNITÉS

PROJECT PROJET

SPEC TYPE

NOTES



FINISH FINI



BLKE

WHE

OVERALL HEIGHT HAUTEUR HORS TOUT

| | LED 0.50" CANOPY |
|-----------------|---------------------|
| MOUNTING | 2471C |
| CABLE & 4049-6 | 69.70" |
| CABLE & 4049-10 | 73.95" |
| CABLE & 4049-18 | 81.45" |

MOUNTING OPTIONS OPTIONS DE MONTAGE

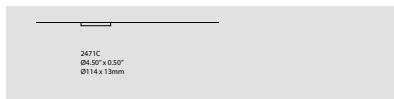

STEM OR CABLE OPTION OPTIONS DE TIGE OU CABLE

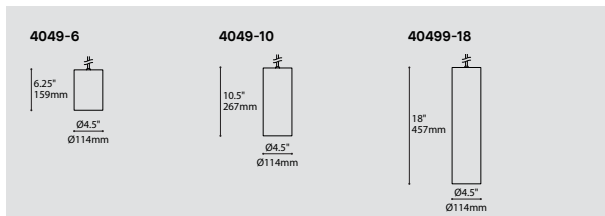
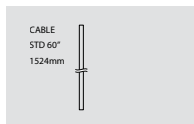

ORDERING SPECIFICATION SPÉCIFICATION DE COMMANDE

CODE

QUICKSHIP

QS

QS QUICKSHIP

MODEL MODÈLE

4049-6 SCOUT 6"
4049-10 SCOUT 10"
4049-18 SCOUT 18"

LIGHT SOURCE SOURCE LUMINEUSE

LED REGULAR OUTPUT
LED.HO HIGH OUTPUT

COLOR TEMPERATURE TEMPÉRATURE DE COULEUR

30 3000K
35 3500K
40 4000K

COLOR RENDERING INDEX (CRI) INDICE DE RENDU DE COULEUR (IRC)

80 80+ CRI

VOLTAGE VOLTAGE

120V 120 VOLT
277V 277 VOLT

DIMMING OPTION OPTION DE GRADATION

DV 0-10V DIMMING (120V-277V)
DP PHASE DIMMING (120V ONLY)
LED DIMMING DRIVER IS STANDARD IN THIS PRODUCT. PLEASE SPECIFY YOUR DIMMING TYPE

BEAM ANGLE ANGLE DE FAISCEAU

NA NARROW (28°)
ME MEDIUM (48°)
WI WIDE (64°)

OPTICAL ACCESSORIES ACCESSOIRES OPTIQUES

CLR CLEAR GLASS LENS
FRO FROSTED GLASS LENS
HON HONEYCOMB LOUVER
SOL SOLITE SOFTENING LENS

CABLE CABLE

C

C* BLACK OR WHITE CABLE, FIELD ADJUSTABLE

*FOR WHITE STRUCTURE: WHITE CABLE, FOR OTHER STRUCTURE FINISH: BLACK CABLE

CABLE LENGTH LONGUEUR DE CABLE

60 60" CABLE (STD LENGTH)
** CUSTOM CABLE LENGTH (PLEASE SPECIFY)
FOR OVERALL LENGTH, PLEASE CONTACT YOUR EUREKA REPRESENTATIVE

MOUNTING MONTAGE

RC

RC ROUND CANOPY / PAVILLON ROND
SCREWLESS 0.5" CANOPY (2471C)

CANOPY FINISH FINI PAVILLON

BLKE BLACK FINE TEXTURE
WHE WHITE FINE TEXTURE

STRUCTURE FINISH FINI STRUCTURE

BLKE BLACK FINE TEXTURE
WHE WHITE FINE TEXTURE

BAFFLE FINISH FINI DÉFLECTEUR

BLKE BLACK FINE TEXTURE
WHE WHITE FINE TEXTURE

ACCESSORY ACCESSOIRE

3983 DEEP JUNCTION BOX (PROVIDED FOR 4049-6 WITH CANOPY)

ADDITIONAL OPTIONS AVAILABLE ON STANDARD SHIPPING / OPTIONS ADDITIONNELLES DISPONIBLES EN LIVRAISON STANDARD

QUICKSHIP

SCOUT 4548

QUICKSHIP

MAXIMUM 20 UNITS / MAXIMUM 20 UNITÉS

PROJECT PROJET

SPEC TYPE

NOTES



FINISH FINI

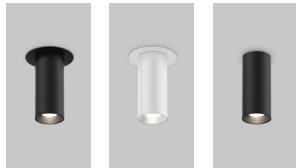

BLKE

WHE

RDP

4548-6 INT

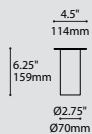

4548-10 INT

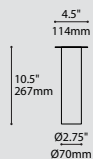

4548-18 INT



4548-6 RDP

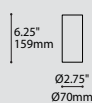

4548-10 RDP

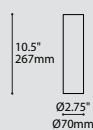

4548-18 RDP



ORDERING SPECIFICATION SPÉCIFICATION DE COMMANDE

CODE

QUICKSHIP

QS

QS QUICKSHIP

MODEL MODÈLE

4548-6 SCOUT 6"
4548-10 SCOUT 10"
4548-18 SCOUT 18"

LIGHT SOURCE SOURCE LUMINEUSE

LED REGULAR OUTPUT
LED.HO HIGH OUTPUT

COLOR TEMPERATURE TEMPÉRATURE DE COULEUR

30 3000K
35 3500K
40 4000K

COLOR RENDERING INDEX (CRI) INDICE DE RENDU DE COULEUR (IRC)

80 80+ CRI

VOLTAGE VOLTAGE

120V 120 VOLT
277V 277 VOLT

DIMMING OPTION OPTION DE GRADATION

DV 0-10V DIMMING (120V-277V)
DP PHASE DIMMING (120V ONLY)

LED DIMMING DRIVER IS STANDARD IN THIS PRODUCT, PLEASE SPECIFY YOUR DIMMING TYPE

BEAM ANGLE ANGLE DE FAISCEAU

NA NARROW (24°)
ME MEDIUM (45°)

OPTICAL ACCESSORIES ACCESSOIRES OPTIQUES

CLR CLEAR GLASS LENS
FRO FROSTED GLASS LENS
HON HONEYCOMB LOUVER
SOL SOLITE SOFTENING LENS

DRIVER & CANOPY OPTION OPTION DE PILOTE & PAVILLON

INT* INTERNAL DRIVER, WITH FLAT CANOPY
RDP RECESSED DRIVER, NO CANOPY

*FOR 4548-6, DRIVER WILL BE IN DEEP JUNCTION BOX

CANOPY FINISH FINI PAVILLON (A)

WHE* WHITE FINE TEXTURE

*IF NO FINISH IS SELECTED, FLAT CANOPY FINISH WILL BE THE SAME AS STRUCTURE FINISH

(A) FILL IN IF INT DRIVER & CANOPY OPTION AND WHE FINISH IS SELECTED, OTHERWISE LEAVE EMPTY

STRUCTURE FINISH FINI STRUCTURE

BLKE BLACK FINE TEXTURE
WHE WHITE FINE TEXTURE

BAFFLE FINISH FINI DÉFLECTEUR

BLKE BLACK FINE TEXTURE
WHE WHITE FINE TEXTURE

ACCESSORY ACCESSOIRE

3983 DEEP JUNCTION BOX (PROVIDED FOR 4548-6 WITH INT OPTION)

ADDITIONAL OPTIONS AVAILABLE ON STANDARD SHIPPING / OPTIONS ADDITIONNELLES DISPONIBLES EN LIVRAISON STANDARD

PRODUCT CHARACTERISTICS CARACTÉRISTIQUES DU PRODUIT



CERTIFIED: c-CSA-us

QUICKSHIP

SCOUT 4549

QUICKSHIP

MAXIMUM 20 UNITS / MAXIMUM 20 UNITÉS

PROJECT PROJET

SPEC TYPE

NOTES



FINISH FINI



BLKE

WHE

4549-6

4549-10

4549-18

6.25"
159mm
Ø4.5"
Ø114mm

10.5"
267mm
Ø4.5"
Ø114mm

18"
457mm
Ø4.5"
Ø114mm

ORDERING SPECIFICATION SPÉCIFICATION DE COMMANDE

CODE

QUICKSHIP

QS

QS QUICKSHIP

MODEL MODÈLE

4549-6 SCOUT 6"
4549-10 SCOUT 10"
4549-18 SCOUT 18"

LIGHT SOURCE SOURCE LUMINEUSE

LED REGULAR OUTPUT
LED.HO HIGH OUTPUT

COLOR TEMPERATURE TEMPÉRATURE DE COULEUR

30 3000K
35 3500K
40 4000K

COLOR RENDERING INDEX (CRI) INDICE DE RENDU DE COULEUR (IRC)

80 80+ CRI

VOLTAGE VOLTAGE

120V 120 VOLT
277V 277 VOLT

DIMMING OPTION OPTION DE GRADATION

DV 0-10V DIMMING (120V-277V)
DP PHASE DIMMING (120V ONLY)

LED DIMMING DRIVER IS STANDARD IN THIS PRODUCT, PLEASE SPECIFY YOUR DIMMING TYPE

BEAM ANGLE ANGLE DE FAISCEAU

NA NARROW (28°)
ME MEDIUM (48°)
WI WIDE (64°)

OPTICAL ACCESSORIES ACCESSOIRES OPTIQUES

CLR CLEAR GLASS LENS
FRO FROSTED GLASS LENS
HON HONEYCOMB LOUVER
SOL SOLITE SOFTENING LENS

STRUCTURE FINISH FINI STRUCTURE

BLKE BLACK FINE TEXTURE
WHE WHITE FINE TEXTURE

BAFFLE FINISH FINI DÉFLECTEUR

BLKE BLACK FINE TEXTURE
WHE WHITE FINE TEXTURE

ACCESSORY ACCESSOIRE

3983 DEEP JUNCTION BOX (PROVIDED FOR 4549-6)

ADDITIONAL OPTIONS AVAILABLE ON STANDARD SHIPPING / OPTIONS ADDITIONNELLES DISPONIBLES EN LIVRAISON STANDARD

PRODUCT CHARACTERISTICS CARACTÉRISTIQUES DU PRODUIT

BIM DIM EMB IES LED

QUICKSHIP



STELLA 4272-9

QUICKSHIP

MAXIMUM 20 UNITS / MAXIMUM 20 UNITÉS

PROJECT PROJET

SPEC TYPE

NOTES



FINISH FINI



BLKE



WHE

4272-9

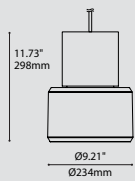

ORDERING SPECIFICATION SPÉCIFICATION DE COMMANDE

CODE

QUICKSHIP

QS

QS QUICKSHIP

MODEL MODÈLE

4272-9

4272-9 STELLA

LIGHT SOURCE SOURCE LUMINEUSE

LED REGULAR OUTPUT
LED.HO HIGH OUTPUT

COLOR TEMPERATURE TEMPÉRATURE DE COULEUR

30 3000K
35 3500K
40 4000K

COLOR RENDERING INDEX (CRI) INDICE DE RENDU DE COULEUR (IRC)

80

80 80+ CRI

VOLTAGE VOLTAGE

120V 120 VOLT
277V 277 VOLT

DIMMING OPTION OPTION DE GRADATION

DV 0-10V DIMMING (120V-277V)
DP PHASE DIMMING (120V ONLY)
LED DIMMING DRIVER IS STANDARD IN THIS PRODUCT, PLEASE SPECIFY YOUR DIMMING TYPE.

STEM OR CABLE TIGE OU CABLE

C

C CABLE, FIELD ADJUSTABLE

STEM OR CABLE LENGTH LONGUEUR DE TIGE OU CABLE

60 60" CABLE (STD LENGTH)
** CUSTOM CABLE LENGTH (PLEASE SPECIFY)
FOR OVERALL LENGTH, PLEASE CONTACT YOUR EUREKA REPRESENTATIVE.

CANOPY FINISH FINI PAVILLON

BLKE BLACK FINE TEXTURE
WHE WHITE FINE TEXTURE

SHADE FINISH FINI ABAT-JOUR (A)(B)

BLKE BLACK FINE TEXTURE
WHE WHITE FINE TEXTURE
(A) SHADE INTERIOR IS ALWAYS WHITE
(B) SHADE FINISH DICTATES THE CABLE COLOR

DIFFUSER FINISH FINI DIFFUSEUR

WH

WH WHITE

ADDITIONAL OPTIONS AVAILABLE ON STANDARD SHIPPING / OPTIONS ADDITIONNELLES DISPONIBLES EN LIVRAISON STANDARD

PRODUCT CHARACTERISTICS CARACTÉRISTIQUES DU PRODUIT

BIM DIM EMB IES LED

- DESIGN:** Stella, at its core, is a powerful light engine fused to a minimalist aluminum shell. A large diffusion dome hidden inside the shade creates a uniform direct & indirect illumination.
- INSTALLATION:** Single power cable or stem for a sleek look.
- LIGHT SOURCE:** A highly powerful COB type light source project a light, softened by a large polymer diffusion dome to create an illumination that is efficient & uniform. Some of the light is reflected upward by the dome; thus illuminating indirectly the ceiling. Offered with phase or 0-10V dimming options.
- STRUCTURE:** Thick extruded aluminium tube with a slotted top to let the heat escape.
- SHADE:** The precision spun aluminum shade is optimised to reduce glare. White internal finish for optimal light reflection.
- CERTIFIED:** c-CSA-us, c-UL-us

QUICKSHIP

SWITCH 7470X

QUICKSHIP

MAXIMUM 20 UNITS / MAXIMUM 20 UNITÉS

PROJECT PROJET

SPEC TYPE

NOTES

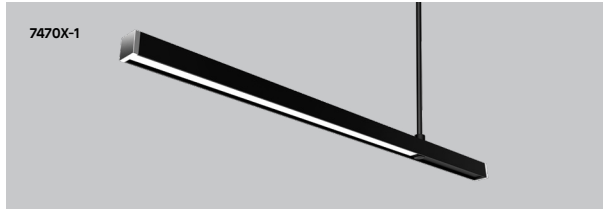

DETAIL DÉTAIL



END CAP DETAIL

MIDDLE STEM DETAIL

BOTTOM CAP DETAIL

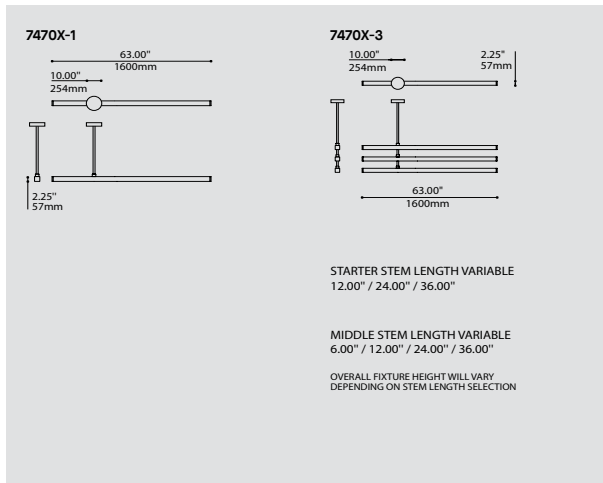

ORDERING SPECIFICATION SPÉCIFICATION DE COMMANDE

CODE

QUICKSHIP

QS

QS QUICKSHIP

MODEL MODÈLE

7470D SWITCH – DIRECT
 7470I SWITCH – INDIRECT

ARM QUANTITY QUANTITÉ DE BRAS

1 1 ARM
 2 2 ARMS
 3 3 ARMS

LIGHT SOURCE SOURCE LUMINEUSE

LED REGULAR OUTPUT

LED

COLOR TEMPERATURE TEMPÉRATURE DE COULEUR

30 3000K
 35 3500K
 40 4000K

COLOR RENDERING INDEX (CRI) INDICE DE RENDU DE COULEUR (IRC)

80 80+ CRI

80

VOLTAGE VOLTAGE

120V 120 VOLT
 277V 277 VOLT

DIMMING OPTION OPTION DE GRADATION

DV 0-10V DIMMING (120V-277V)
 DP PHASE DIMMING (120V ONLY)

LED DIMMING DRIVER IS STANDARD IN THIS PRODUCT, PLEASE SPECIFY YOUR DIMMING TYPE

STEM TIGE

S7 27/32", (21MM) STEM, NOT FIELD ADJUSTABLE

* FOR WHITE HEAD FINISH: WHITE CABLE, FOR OTHER HEAD FINISH: BLACK CABLE

S7

STARTER STEM LENGTH LONGUEUR DE TIGE DU DÉBUT

12 12" STEM
 24 24" STEM
 36 36" STEM

FOR OVERALL LENGTH, PLEASE CONTACT YOUR EUREKA REPRESENTATIVE

MIDDLE STEM LENGTH LONGUEUR DE TIGE DU MILIEU^(A)

6 6" STEM
 12 12" STEM
 24 24" STEM
 36 36" STEM

^(A) ALL MIDDLE STEMS WILL BE THE SAME LENGTH

STRUCTURE FINISH FINI STRUCTURE

BLK BLACK
 WH WHITE

END CAP FINISH FINI EMBOUIT

CHR CHROME
 BLK BLACK
 WH WHITE

ADDITIONAL OPTIONS AVAILABLE ON STANDARD SHIPPING / OPTIONS ADDITIONNELLES DISPONIBLES EN LIVRAISON STANDARD

PRODUCT CHARACTERISTICS CARACTÉRISTIQUES DU PRODUIT



DESIGN:

Functionally luxurious, this expandable luminaire system marries a minimal aesthetic with elegant technology to provide a highly versatile and unique lighting experience.

INSTALLATION:

Arm quantity and stem lengths can be specified to create fixtures as big as required, with the individual arms installed to provide direct or indirect light. Each arm has its own precision balance control, and an intelligent bearing component that facilitates 350° arm rotation.

LIGHT SOURCE:

Each arm conceals a custom designed LED module and dimmable driver.

STRUCTURE:

The precision aluminum body, heavy gauge mounting bracket and thick-walled steel stem is powder coated white or black.

DIFFUSER:

Recessed back from the opening aperture, the extruded high performance lens seems to float in the housing. Using custom blended PMMA and an added holographic diffuser film, Switch offers efficient yet fully diffused surface illumination.

CERTIFIED:

c-CSA-us



GIPHY
New York City, New York, USA

Photo Credit: Ashok Sinha

TONE 2990IE

QUICKSHIP

MAXIMUM 20 UNITS / MAXIMUM 20 UNITÉS

PROJECT PROJET

SPEC TYPE

NOTES



2990IE-24

Ø47.00"
Ø1180mm
Ø18.00"
Ø460mm

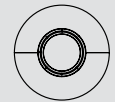

5.10"
130mm

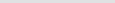

2990IE-36

Ø58.00"
Ø1475mm
Ø30.00"
Ø760mm

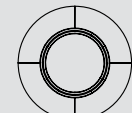

5.10"
130mm

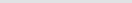

2990IE-54

Ø76.00"
Ø1930mm
Ø48.00"
Ø1200mm

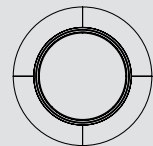

5.10"
130mm

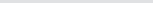

ORDERING SPECIFICATION SPÉCIFICATION DE COMMANDE

CODE

QUICKSHIP

QS

QS QUICKSHIP

MODEL MODÈLE (A)

2990IE-24 TONE EXTERIOR-INTERIOR CHARCOAL FELT – 24"

2990IE-36 TONE EXTERIOR-INTERIOR CHARCOAL FELT – 36"

2990IE-54 TONE EXTERIOR-INTERIOR CHARCOAL FELT – 54"

(A) CYCLE SOLD SEPARATELY

STRUCTURE FINISH FINI STRUCTURE

CHF

CHF CHARCOAL FELT

ADDITIONAL OPTIONS AVAILABLE ON STANDARD SHIPPING / OPTIONS ADDITIONNELLES DISPONIBLES EN LIVRAISON STANDARD

PRODUCT CHARACTERISTICS CARACTÉRISTIQUES DU PRODUIT



DESIGN:

A sound absorbing structure that installs onto the Cycle luminaire to improve the sound quality of your space. It uses a proven ecological sound absorbing material to reduce unwanted reflected sounds to dampen ambient noises.

INSTALLATION:

It installs quickly and without the need of tools on an existing suspended Cycle luminaire (sold separately).

STRUCTURE:

Acoustic panels are composed of a light, rigid and ecological synthetic felt. Made from recycled and recyclable polyester (PET) fibers that have low VOCs, no formaldehyde, are non-irritable and odourless.

COMPATIBILITY:

Can be installed on suspended Cycle sizes 24, 36, 54. Not compatible with Cycle layers (4844) or Cycle wall or ceiling mounted (3800). Can be installed on suspended Cycle at angle up to 30 degrees.

CERTIFIED:

Acoustic: ASTM C423 0.65 NRC/SAA 0.66. Test RAL-A15-387 Riverbank Acoustical laboratories. Fire rating: Equivalent to C423 ASTM E-84/CAN ULC S102 Class A.

CONCEPTION:

S'intègre avec le luminaire Cycle pour améliorer la qualité sonore de votre espace de façon simple et non intrusive. Il est composé d'un matériau acoustique éprouvé qui contribue à absorber les sons nuisibles se reflétant dans une pièce.

INSTALLATION:

S'installe rapidement et sans outils sur un luminaire Cycle suspendu (vendu séparément).

STRUCTURE:

Panneau acoustique fait de feutre synthétique rigide, léger et écologique.

COMPATIBILITÉ:

Peut être installé sur une suspension Cycle grandeur 24, 36, 54 (vendu séparément).

N'est pas compatible avec le Cycle Layers (4844), murales ou plafonniers (3800).

Peut être installé sur un Cycle suspendu jusqu'à 30 degrés d'angle.

CERTIFIÉ:

Acoustique: ASTM C423: NRC 0.65/SAA 0.66. Test RAL-A15-387 Laboratoires acoustiques Riverbank. Résistance Feu: Équivalent à ASTM E-84/CAN ULC S102 Classe A.

QUICKSHIP

TONE 2990E

QUICKSHIP

MAXIMUM 20 UNITS / MAXIMUM 20 UNITÉS

PROJECT PROJET

SPEC TYPE

NOTES

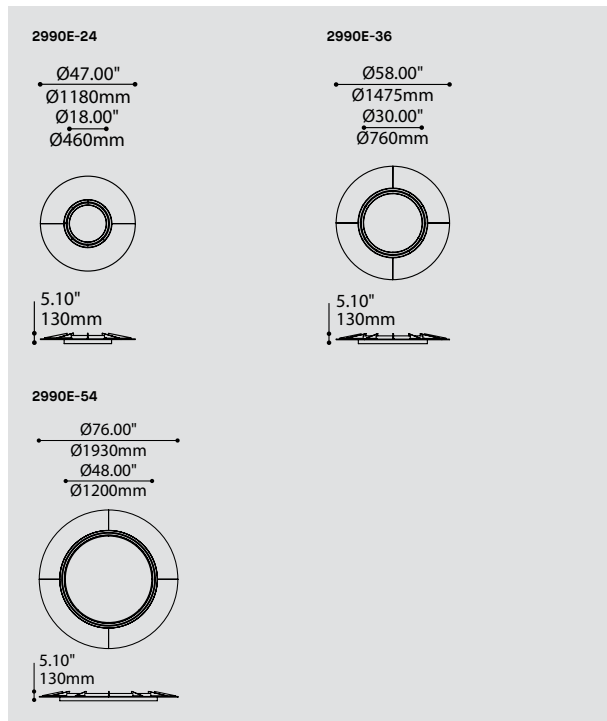

ORDERING SPECIFICATION SPÉCIFICATION DE COMMANDE

CODE

QUICKSHIP

QS

QS QUICKSHIP

MODEL MODÈLE (A)

2990E-24 TONE EXTERIOR CHARCOAL FELT – 24"
 2990E-36 TONE EXTERIOR CHARCOAL FELT – 36"
 2990E-54 TONE EXTERIOR CHARCOAL FELT – 54"
(A) CYCLE SOLD SEPARATELY

STRUCTURE FINISH FINI STRUCTURE

CHF

CHF CHARCOAL FELT

ADDITIONAL OPTIONS AVAILABLE ON STANDARD SHIPPING / OPTIONS ADDITIONNELLES DISPONIBLES EN LIVRAISON STANDARD

PRODUCT CHARACTERISTICS CARACTÉRISTIQUES DU PRODUIT



- DESIGN:** A sound absorbing structure that installs onto the Cycle luminaire to improve the sound quality of your space. It uses a proven ecological sound absorbing material to reduce unwanted reflected sounds to dampen ambient noises.
- INSTALLATION:** It installs quickly and without the need of tools on an existing suspended Cycle luminaire (sold separately).
- STRUCTURE:** Acoustic panels are composed of a light, rigid and ecological synthetic felt. Made from recycled and recyclable polyester (PET) fibers that have low VOCs, no formaldehyde, are non-irritable and odourless.
- COMPATIBILITY:** Can be installed on suspended Cycle sizes 24, 36, 54. Not compatible with Cycle layers (4844) or Cycle wall or ceiling mounted (3800). Can be installed on suspended Cycle at angle up to 30 degrees.
- CERTIFIED:** Acoustic: ASTM C423 0.65 NRC/SAA 0.66. Test RAL-A15-387 Riverbank Acoustical laboratories. Fire rating: Equivalent to C423 ASTM E-84/CAN ULC S102 Class A.
- CONCEPTION:** S'intègre avec le luminaire Cycle pour améliorer la qualité sonore de votre espace de façon simple et non intrusive. Il est composé d'un matériau acoustique éprouvé qui contribue à absorber les sons nuisibles se reflétant dans une pièce.
- INSTALLATION:** S'installe rapidement et sans outils sur un luminaire Cycle suspendu (vendu séparément).
- STRUCTURE:** Panneau acoustique fait de feutre synthétique rigide, léger et écologique. Fait de fibres de polyéthylène (PET) recyclées et recyclables avec bas COV, sans formaldéhyde, non irritabile et inodore.
- COMPATIBILITÉ:** Peut être installé sur une suspension Cycle grandeur 24, 36, 54 (vendu séparément). N'est pas compatible avec le Cycle Layers (4844), murales ou plafonniers (3800). Peut être installé sur un Cycle suspendu jusqu'à 30 degrés d'angle.
- CERTIFIÉ:** Acoustique: ASTM C423: NRC 0.65/SAA 0.66. Test RAL-A15-387 Laboratoires acoustiques Riverbank. Résistance Feu: Équivalent à ASTM E-84/CAN ULC S102 Classe A.

TONE 2990I

QUICKSHIP

MAXIMUM 20 UNITS / MAXIMUM 20 UNITÉS

PROJECT PROJET

SPEC TYPE

NOTES



2990I-24

Ø18.00"
Ø460mm



2990I-36

Ø30.00"
Ø760mm



2990I-54

Ø48.00"
Ø1200mm



ORDERING SPECIFICATION SPÉCIFICATION DE COMMANDE

CODE

QUICKSHIP

QS

QS QUICKSHIP

MODEL MODÈLE (A)

2990I-24 TONE INTERIOR CHARCOAL FELT – 24"
2990I-36 TONE INTERIOR CHARCOAL FELT – 36"
2990I-54 TONE INTERIOR CHARCOAL FELT – 54"

(A) CYCLE SOLD SEPARATELY

STRUCTURE FINISH FINI STRUCTURE

CHF

CHF CHARCOAL FELT

ADDITIONAL OPTIONS AVAILABLE ON STANDARD SHIPPING / OPTIONS ADDITIONNELLES DISPONIBLES EN LIVRAISON STANDARD

PRODUCT CHARACTERISTICS CARACTÉRISTIQUES DU PRODUIT



DESIGN:

A sound absorbing structure that installs onto the Cycle luminaire to improve the sound quality of your space. It uses a proven ecological sound absorbing material to reduce unwanted reflected sounds to dampen ambient noises.

INSTALLATION:

It installs quickly and without the need of tools on an existing suspended Cycle luminaire (sold separately).

STRUCTURE:

Acoustic panels are composed of a light, rigid and ecological synthetic felt. Made from recycled and recyclable polyester (PET) fibers that have low VOCs, no formaldehyde, are non-irritable and odourless.

COMPATIBILITY:

Can be installed on suspended Cycle sizes 24, 36, 54. Not compatible with Cycle layers (4844) or Cycle wall or ceiling mounted (3800). Can be installed on suspended Cycle at angle up to 30 degrees.

CERTIFIED:

Acoustic: ASTM C423 0.65 NRC/SAA 0.66. Test RAL-A15-387 Riverbank Acoustical laboratories. Fire rating: Equivalent to C423 ASTM E-84/CAN ULC S102 Class A.

CONCEPTION:

S'intègre avec le luminaire Cycle pour améliorer la qualité sonore de votre espace de façon simple et non intrusive. Il est composé d'un matériau acoustique éprouvé qui contribue à absorber les sons nuisibles se reflétant dans une pièce.

INSTALLATION:

S'installe rapidement et sans outils sur un luminaire Cycle suspendu (vendu séparément).

STRUCTURE:

Panneau acoustique fait de feutre synthétique rigide, léger et écologique.

COMPATIBILITÉ:

Peut être installé sur une suspension Cycle grandeur 24, 36, 54 (vendu séparément).

N'est pas compatible avec le Cycle Layers (4844), murales ou plafonniers (3800).

Peut être installé sur un Cycle suspendu jusqu'à 30 degrés d'angle.

CERTIFIÉ:

Acoustique: ASTM C423: NRC 0.65/SAA 0.66. Test RAL-A15-387 Laboratoires acoustiques Riverbank. Résistance Feu: Équivalent à ASTM E-84/CAN ULC S102 Classe A.



TWIN 4268

QUICKSHIP

MAXIMUM 20 UNITS / MAXIMUM 20 UNITÉS

PROJECT PROJET

SPEC TYPE

NOTES



FINISH FINI

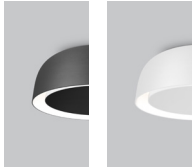

BLKE

WHE

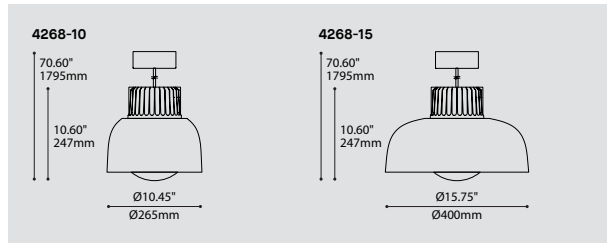

ORDERING SPECIFICATION SPÉCIFICATION DE COMMANDE

CODE

QUICKSHIP

QS

QS QUICKSHIP

MODEL MODÈLE

4268-10 TWIN 10"

4268-15 TWIN 15"

4268-10-DD* TWIN 10" (DUAL DIMMING)

4268-15-DD* TWIN 15" (DUAL DIMMING)

*INNER AND OUTER LIGHT SOURCES ARE DIMMED INDEPENDENTLY

LIGHT SOURCE SOURCE LUMINEUSE

LED

LED REGULAR OUTPUT

COLOR TEMPERATURE TEMPÉRATURE DE COULEUR

30 3000K

35 3500K

40 4000K

COLOR RENDERING INDEX (CRI) INDICE DE RENDU DE COULEUR (IRC)

80

80 80+ CRI

VOLTAGE VOLTAGE

120V 120 VOLT

277V 277 VOLT

DIMMING OPTION OPTION DE GRADATION

DV 0-10V DIMMING (120V-277V)

DP PHASE DIMMING (120V ONLY)

LED DIMMING DRIVER IS STANDARD IN THIS PRODUCT. PLEASE SPECIFY YOUR DIMMING TYPE.

BEAM ANGLE ANGLE DE FAISCEAU

20 20° LENS

40 40° LENS

CABLE CABLE

C

C BLACK CABLE, FIELD ADJUSTABLE

CABLE LENGTH LONGUEUR DE CABLE

60 60" CABLE (STD LENGTH)

** CUSTOM CABLE LENGTH (PLEASE SPECIFY)

FOR OVERALL LENGTH, PLEASE CONTACT YOUR EUREKA REPRESENTATIVE.

CANOPY FINISH FINI PAVILLON

BLKE BLACK FINE TEXTURE

WHE WHITE FINE TEXTURE

SHADE FINISH FINI ABAT-JOUR (A) (B)

BLKE BLACK FINE TEXTURE

WHE WHITE FINE TEXTURE

(A) FINISH BETWEEN SHADES IS ALWAYS WHITE

(B) HEATSINK IS ALWAYS BLACK

ADDITIONAL OPTIONS AVAILABLE ON STANDARD SHIPPING / OPTIONS ADDITIONNELLES DISPONIBLES EN LIVRAISON STANDARD

PRODUCT CHARACTERISTICS CARACTÉRISTIQUES DU PRODUIT

BIM DIM EMB IES LED

QUICKSHIP

TWIN 4768

QUICKSHIP

MAXIMUM 20 UNITS / MAXIMUM 20 UNITÉS

PROJECT PROJET

SPEC TYPE

NOTES



FINISH FINI

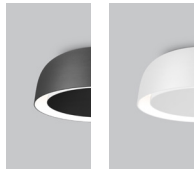

BLKE

WHE

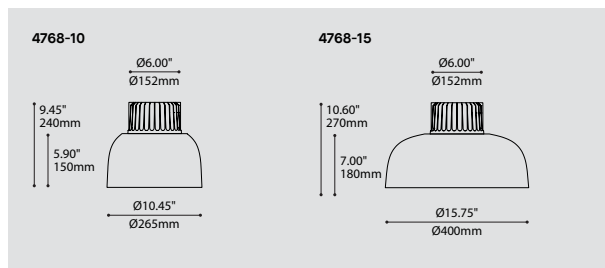

ORDERING SPECIFICATION SPÉCIFICATION DE COMMANDE

CODE

QUICKSHIP

QS

QS QUICKSHIP

MODEL MODÈLE

4768-10 TWIN 10"

4768-15 TWIN 15"

4768-10-DD* TWIN 10" (DUAL DIMMING)

4768-15-DD* TWIN 15" (DUAL DIMMING)

*INNER AND OUTER LIGHT SOURCES ARE DIMMED INDEPENDENTLY

LIGHT SOURCE SOURCE LUMINEUSE

LED

LED REGULAR OUTPUT

COLOR TEMPERATURE TEMPÉRATURE DE COULEUR

30 3000K

35 3500K

40 4000K

COLOR RENDERING INDEX (CRI) INDICE DE RENDU DE COULEUR (IRC)

80

80 80+ CRI

VOLTAGE VOLTAGE

120V 120 VOLT

277V 277 VOLT

DIMMING OPTION OPTION DE GRADATION

DV 0-10V DIMMING (120V-277V)

DP PHASE DIMMING (120V ONLY)

LED DIMMING DRIVER IS STANDARD IN THIS PRODUCT. PLEASE SPECIFY YOUR DIMMING TYPE.

BEAM ANGLE ANGLE DE FAISCEAU

20 20° LENS

40 40° LENS

HEATSINK FINISH FINI RADIATEUR

BLKE

BLKE BLACK FINE TEXTURE

SHADE FINISH FINI ABAT-JOUR (A)

BLKE BLACK FINE TEXTURE

WHE WHITE FINE TEXTURE

(A) FINISH BETWEEN SHADES IS ALWAYS WHITE

ACCESSORY ACCESSOIRE

3983

3983 DEEP JUNCTION BOX

ADDITIONAL OPTIONS AVAILABLE ON STANDARD SHIPPING / OPTIONS ADDITIONNELLES DISPONIBLES EN LIVRAISON STANDARD

PRODUCT CHARACTERISTICS CARACTÉRISTIQUES DU PRODUIT

BIM DIM EMB IES LED

DESIGN:

Twin is a light fixture with a simple and charming shape composed of a double layered shade sheltering a soft halo of indirect light. The core of these two shades hides a powerful projector providing a strong direct light. Twin is available in two sizes and in a variety of colorful finishes.

INSTALLATION:

Ceiling installation on deep junction box (supplied with light fixture).

LIGHT SOURCE:

Powerful LED projector with a 20° or 40° projection angle, and a circular LED module that projects a soft and cozy indirect light, diffused between the shades. Offered with phase or 0-10V gradation options.

STRUCTURE:

High-performance die-cast aluminum heatsink with textured black finish. Spun aluminum shades, offered in a wide variety of external finishes with a white internal finish for optimal light reflection.

CERTIFIED:

c-CSA-us, c-UL-us

QUICKSHIP

TWIN 1208

QUICKSHIP

MAXIMUM 20 UNITS / MAXIMUM 20 UNITÉS

PROJECT PROJET

SPEC TYPE

NOTES



FINISH FINI



BLKE

WHE

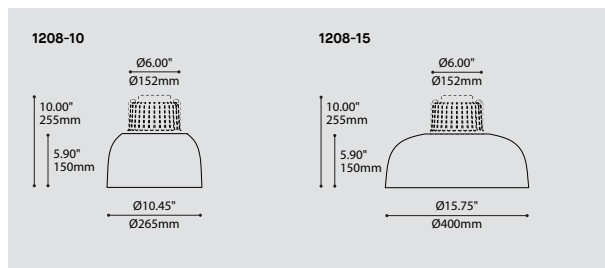

ORDERING SPECIFICATION SPÉCIFICATION DE COMMANDE

CODE

QUICKSHIP

QS

QS QUICKSHIP

MODEL MODÈLE

1208-10 TWIN 10"
 1208-15 TWIN 15"
 1208-10-DD* TWIN 10" (DUAL DIMMING)
 1208-15-DD* TWIN 15" (DUAL DIMMING)
 1208-10-IC TWIN 10" (INSULATED CEILING)
 1208-15-IC TWIN 15" (INSULATED CEILING)

*INNER AND OUTER LIGHT SOURCES ARE DIMMED INDEPENDENTLY

LIGHT SOURCE SOURCE LUMINEUSE

LED

LED REGULAR OUTPUT

COLOR TEMPERATURE TEMPÉRATURE DE COULEUR

30 3000K
 35 3500K
 40 4000K

COLOR RENDERING INDEX (CRI) INDICE DE RENDU DE COULEUR (IRC)

80

80 80+ CRI

VOLTAGE VOLTAGE

120V 120 VOLT
 277V 277 VOLT

DIMMING OPTION OPTION DE GRADATION

DV 0-10V DIMMING (120V-277V)
 DP PHASE DIMMING (120V ONLY)

LED DIMMING DRIVER IS STANDARD IN THIS PRODUCT, PLEASE SPECIFY YOUR DIMMING TYPE.

BEAM ANGLE ANGLE DE FAISCEAU

20 20° LENS
 40 40° LENS

SHADE FINISH FINI ABAT-JOUR^(A)

BLKE BLACK FINE TEXTURE
 WHE WHITE FINE TEXTURE

^(A) FINISH BETWEEN SHADES IS ALWAYS WHITE

ADDITIONAL OPTIONS AVAILABLE ON STANDARD SHIPPING / OPTIONS ADDITIONNELLES DISPONIBLES EN LIVRAISON STANDARD

PRODUCT CHARACTERISTICS CARACTÉRISTIQUES DU PRODUIT



DESIGN:

Twin is a light fixture with a simple and charming shape composed of a double layered shade sheltering a soft halo of indirect light. The core of these two shades hides a powerful projector providing a strong direct light. Twin is available in two sizes and in a variety of colorful finishes.

INSTALLATION:

Recessed mounting system allows for simple and secure installation in a variety of ceiling types from 0.375" (9.5mm) to 2.75" (70mm) thick, accommodating renovation projects.

LIGHT SOURCE:

Powerful LED projector with a 20° or 40° projection angle, and a circular LED module that projects a soft and cozy indirect light, diffused between the shades. Offered with phase or 0-10V gradation options.

STRUCTURE:

High-performance die-cast aluminum heatsink with textured black finish. Spun aluminum shades, offered in a wide variety of external finishes with a white internal finish for optimal light reflection.

CERTIFIED:

c-CSA-us

QUICKSHIP



TUMBLER 3409

QUICKSHIP

MAXIMUM 20 UNITS / MAXIMUM 20 UNITÉS

PROJECT PROJET

SPEC TYPE

NOTES



3409

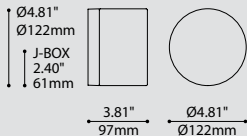

ORDERING SPECIFICATION SPÉCIFICATION DE COMMANDE

CODE

QUICKSHIP

QS

QS QUICKSHIP

MODEL MODÈLE

3409

3409 TUMBLER

LIGHT SOURCE SOURCE LUMINEUSE

LED.4 4W, LED
LED.8 8W, LED

COLOR TEMPERATURE TEMPÉRATURE DE COULEUR

30 3000K
35 3500K
40 4000K

VOLTAGE VOLTAGE

120V 120 VOLT
277V 277 VOLT

DIMMING OPTION OPTION DE GRADATION

DV* 0-10V DIMMING (120V-277V)
DP* PHASE DIMMING (120V ONLY)
*3983 ACCESSORY IS PROVIDED FOR DIMMING OPTION

STRUCTURE FINISH FINI STRUCTURE

ANTE ANTHRACITE FINE TEXTURE
BLKE BLACK FINE TEXTURE

DIFFUSER FINISH FINI DIFFUSEUR

CFR

CFR CLEAR - FROSTED

ACCESSORY ACCESSOIRE

3981 DEEP JUNCTION BOX (PROVIDED FOR DIMMING OPTION)

ADDITIONAL OPTIONS AVAILABLE ON STANDARD SHIPPING / OPTIONS ADDITIONNELLES DISPONIBLES EN LIVRAISON STANDARD

PRODUCT CHARACTERISTICS CARACTÉRISTIQUES DU PRODUIT



- DESIGN:** Tumbler is a small jewel made from tough machined glass. Its crisp, minimal form provides seamless accent illumination for any indoor or outdoor environment.
- LIGHT SOURCE:** Custom designed energy saving LED light source. Tumbler has an integral heatsink and has been tested to assure a long lifetime.
- STRUCTURE:** Die-cast aluminum base with anthracite or black exterior grade fine texture finish.
- DIFFUSER:** Designed to be both beautiful and durable, Tumbler is a machined heavy glass with an inside frosted surface for better diffusion.
- CERTIFIED:** CSA Listed to US and Canadian safety standards; 25°C ambient and wet-locations. IP65 rated
- CONCEPTION:** Le Tumbler est un petit bijou fait de verre machiné robuste. Sa forme géométrique minimaliste procure une lumière ambiante diffuse qui réhausse tout environnement intérieur ou extérieur.
- SOURCE LUMINEUSE:** Modèle DEL conçu sur mesure à faible consommation. Le Tumbler intègre un dissipateur de chaleur testé pour prolonger sa durée de vie.
- STRUCTURE:** Base en aluminium moulé sous pression finition peinture anthracite ou noire finement texturée de grade extérieur.
- DIFFUSER:** Conçu pour être à la fois beau et durable, le Tumbler est machiné à même un bloc de verre et est ensuite givré à l'intérieur pour une meilleure diffusion.
- CERTIFIÉ:** Homologué CSA aux standards UL Canada et É.-U. - Température ambiante 25°C et emplacements mouillés. Conforme à la norme IP65



VALCO 4259

QUICKSHIP

MAXIMUM 20 UNITS / MAXIMUM 20 UNITÉS

PROJECT PROJET

SPEC TYPE

NOTES



FINISH FINI



ANTE

WHE

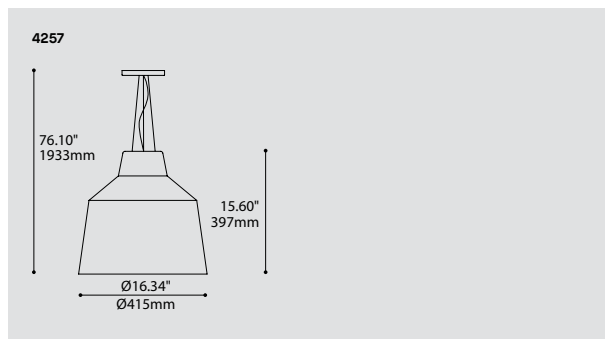

ORDERING SPECIFICATION SPÉCIFICATION DE COMMANDE

CODE

QUICKSHIP

QS

QS QUICKSHIP

MODEL MODÈLE

4259

4259 VALCO

LIGHT SOURCE SOURCE LUMINEUSE

LED.24

LED.24 24W, LED

COLOR TEMPERATURE TEMPÉRATURE DE COULEUR

30 3000K

35 3500K

40 4000K

COLOR RENDERING INDEX (CRI) INDICE DE RENDU DE COULEUR (IRC)

80

80 80+ CRI

VOLTAGE VOLTAGE

120V 120 VOLT

277V 277 VOLT

DIMMING OPTION OPTION DE GRADATION

DV 0-10V DIMMING (120V-277V)

DP PHASE DIMMING (120V ONLY)

LED DIMMING DRIVER IS STANDARD IN THIS PRODUCT, PLEASE SPECIFY YOUR DIMMING TYPE

CABLE CÂBLE

AC

AC AIR-CRAFT MOUNTING & CLEAR CABLE, FIELD ADJUSTABLE

CABLE LENGTH LONGUEUR DE CÂBLE

60 60" AIRCRAFT CABLE (STD LENGTH)

** CUSTOM AIRCRAFT CABLE LENGTH (PLEASE SPECIFY)

FOR OVERALL LENGTH, PLEASE CONTACT YOUR EUREKA REPRESENTATIVE

CANOPY FINISH FINI PAVILLON

WHE

WHE WHITE FINE TEXTURE

SHADE FINISH FINI ABAT-JOUR

WHE WHITE FINE TEXTURE

ANTE ANTHRACITE FINE TEXTURE

ADDITIONAL OPTIONS AVAILABLE ON STANDARD SHIPPING / OPTIONS ADDITIONNELLES DISPONIBLES EN LIVRAISON STANDARD

PRODUCT CHARACTERISTICS CARACTÉRISTIQUES DU PRODUIT

BIM DIM EMB IES LED

DESIGN:

The minimalist silhouette distinguishes itself by its unique lines which gives it a contemporary tone. Suspended alone or in a group, Valco creates a soft and comfortable illumination throughout the room.

INSTALLATION:

Easy to install, adjust and level triple aircraft cable mounting.

LIGHT SOURCE:

24W custom LED light engine supplied with a standard dimming driver (0-10V or phase).

STRUCTURE:

Die-formed steel canopy with a machined aluminum diffuser support.

SHADE:

Custom spun aluminum shade anthracite or white architectural grade fine texture finishes.

CERTIFIED:

c-CSA-us

CONCEPTION:

Ce luminaire à la silhouette épurée se distingue par ses arrêtes prononcées qui lui donnent un ton actuel. Suspendu seul ou en groupe, il crée une douce illumination à travers la pièce.

INSTALLATION:

Câbles de retenue en acier facilitant l'installation, l'ajustement et la mise à niveau.

SOURCE LUMINEUSE:

Module lumineux DEL de 24W fait sur mesure et unité d'alimentation à intensité variable standard (0-10V ou phase).

STRUCTURE:

Structure d'acier et support à diffuseur usiné en aluminium.

ABAT-JOUR:

Abat-jour en métal repoussé avec une peinture anthracite ou blanche finement texturée de grade architectural.

CERTIFIÉ:

c-CSA-us

QUICKSHIP

VERNER 4273-14

QUICKSHIP

MAXIMUM 20 UNITS / MAXIMUM 20 UNITÉS

PROJECT PROJET

SPEC TYPE

NOTES



FINISH FINI



BLKE



WHE

4273-14

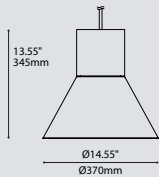

ORDERING SPECIFICATION SPÉCIFICATION DE COMMANDE

CODE

QUICKSHIP

QS

QS QUICKSHIP

MODEL MODÈLE

4273-14

4273-14 VERNER

LIGHT SOURCE SOURCE LUMINEUSE

LED REGULAR OUTPUT
LED.HO HIGH OUTPUT

COLOR TEMPERATURE TEMPÉRATURE DE COULEUR

30 3000K
35 3500K
40 4000K

COLOR RENDERING INDEX (CRI) INDICE DE RENDU DE COULEUR (IRC)

80

80 80+ CRI

VOLTAGE VOLTAGE

120V 120 VOLT
277V 277 VOLT

DIMMING OPTION OPTION DE GRADATION

DV 0-10V DIMMING (120V-277V)
DP PHASE DIMMING (120V ONLY)
LED DIMMING DRIVER IS STANDARD IN THIS PRODUCT. PLEASE SPECIFY YOUR DIMMING TYPE.

STEM OR CABLE TIGE OU CABLE

C

C CABLE, FIELD ADJUSTABLE

STEM OR CABLE LENGTH LONGUEUR DE TIGE OU CABLE

60 60" CABLE (STD LENGTH)
** CUSTOM CABLE LENGTH (PLEASE SPECIFY)
FOR OVERALL LENGTH, PLEASE CONTACT YOUR EUREKA REPRESENTATIVE.

CANOPY FINISH FINI PAVILLON

BLKE BLACK FINE TEXTURE
WHE WHITE FINE TEXTURE

SHADE FINISH FINI ABAT-JOUR (A)(B)

BLKE BLACK FINE TEXTURE
WHE WHITE FINE TEXTURE
(A) SHADE INTERIOR IS ALWAYS WHITE
(B) SHADE FINISH DICTATES THE CABLE COLOR

DIFFUSER FINISH FINI DIFFUSEUR

WH

WH WHITE

ADDITIONAL OPTIONS AVAILABLE ON STANDARD SHIPPING / OPTIONS ADDITIONNELLES DISPONIBLES EN LIVRAISON STANDARD

PRODUCT CHARACTERISTICS CARACTÉRISTIQUES DU PRODUIT

BIM DIM EMB IES LED

- DESIGN:** Verner, at its core, is a powerful light engine fused to a timeless geometric aluminum shell. A diffusion dome hidden inside the shade create a uniform illumination.
- INSTALLATION:** Single power cable or stem for a minimalist look.
- LIGHT SOURCE:** A highly powerful COB type light source project a light, softened by a polymer diffusion dome to create an illumination that is efficient, yet soft to the eye. Offered with phase or 0-10V dimming options.
- STRUCTURE:** Thick extruded aluminium tube with a slotted top to let the heat escape.
- SHADE:** Precision spun aluminium shade, with a white internal finish for optimal light reflection.
- CERTIFIED:** c-CSA-us, c-UL-us



www.eurekalighting.com