

INSTALLATION MAINTENANCE

Spotlight, wall surface and suspended fixture Projecteur, applique murale et suspension

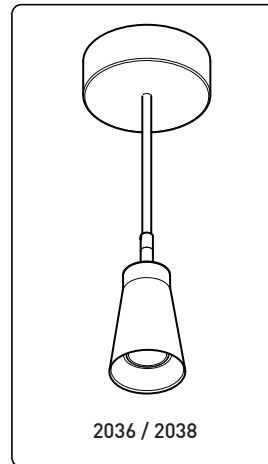

BULBS AMPOULES

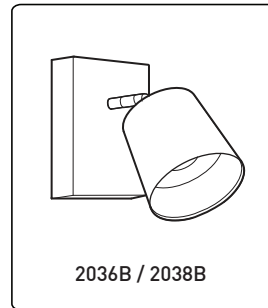
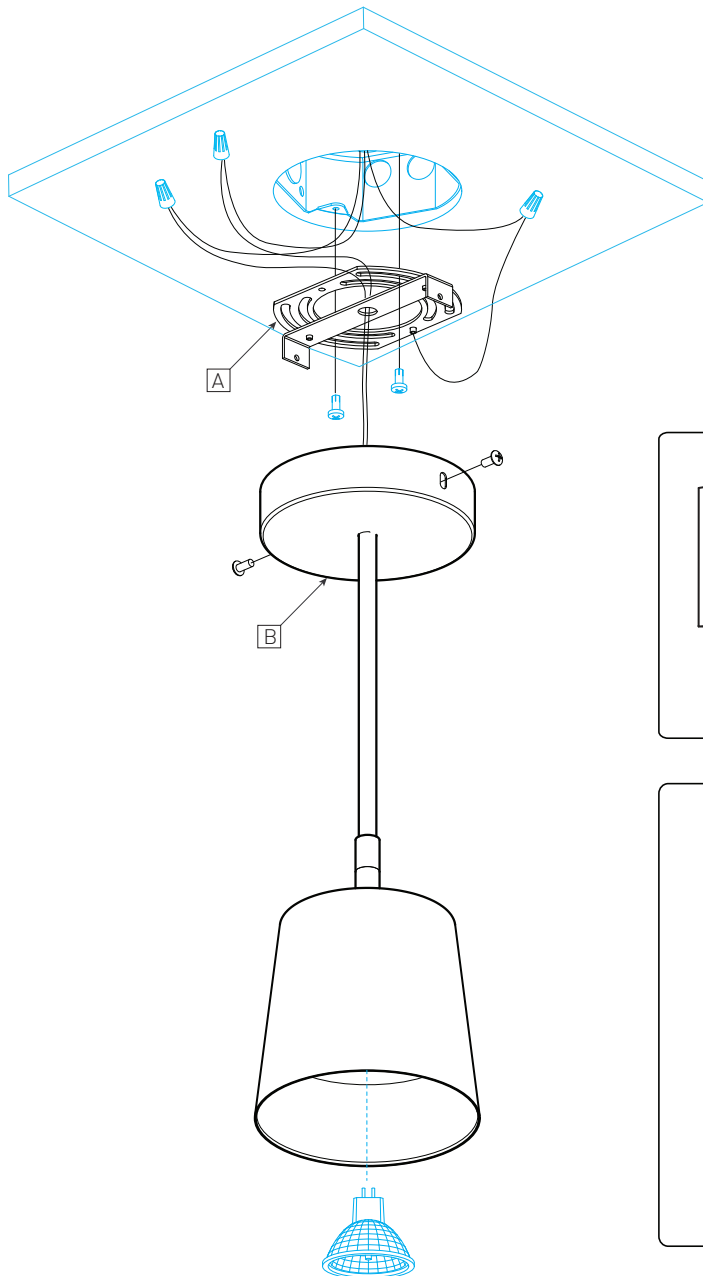
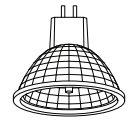

MR16C.50W

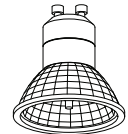

GZ10.50W

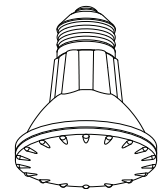

PAR20.50W



LED.4W

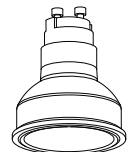

CMH MR16.20W

INSTALLATION

REMOVE SCREWS [A] (8-32 X 3/8in) TO RELEASE THE CANOPY [B] FROM THE UNIVERSAL CROSSBAR [C].

- 1 - INSTALLATION ON JUNCTION BOX
INSTALL THE UNIVERSAL PLATE [A], AND MAKE THE ELECTRICAL CONNECTIONS.
(WIRE NUTS AND SCREWS NOT SUPPLIED)
- 2 - INSTALL THE CANOPY [B] AND SCREW INTO PLACE.

MAINTENANCE

- 3 - EXCEPT FOR LED VERSION, INSERT LAMPS (NOT SUPPLIED) INTO SOCKETS.

INSTALLATION

DÉVISSER LES 2 VIS [A] (8-32 X 3/8in) POUR LIBÉRER LE PAVILLON [B] DE LA PLAQUE UNIVERSELLE [C].

- 1 - INSTALLATION BOÎTE ELECTRIQUE
INSTALLER LA PLAQUE UNIVERSELLE [A] ET FAIRE LA CONNEXION DES FILS.
(MARRETTES ET VIS NON INCLUSES)
- 2 - INSTALLER LE PAVILLON [B] ET VISSER EN PLACE.

MAINTENANCE

- 3 - SAUF POUR LA VERSION LED, INSÉRER LES AMPOULES (NON FOURNIES) DANS LES DOUILLES.



225 de Liège Ouest, Suite #200
Montréal (QC), Canada H2P 1H4
Tel : 514.385.3515 Fax : 514.385.4169
www.eurekalighting.com



2036 | 2038 | 2036B | 2038B | 4036 | 4038
Slim Stack | Stubby Stack