

OSLO 3038-19

PROJECT PROJET
SPEC TYPE
NOTES

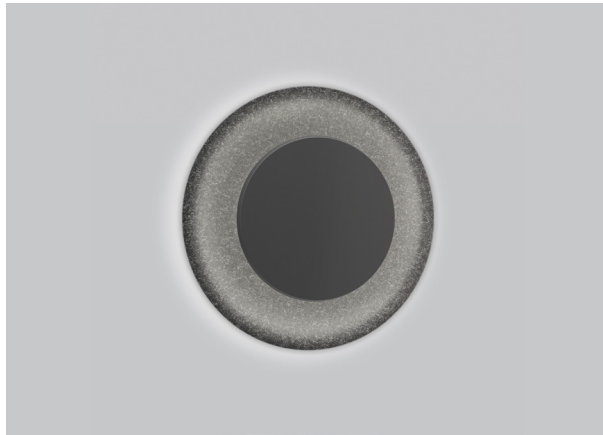

FAMILY FAMILLE



4238-19 3038-19 (WALL) 4238-19

OPTIONS

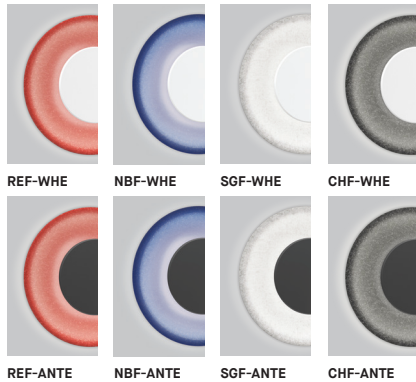

REF-WHE NBF-WHE SGF-WHE CHF-WHE
REF-ANTE NBF-ANTE SGF-ANTE CHF-ANTE

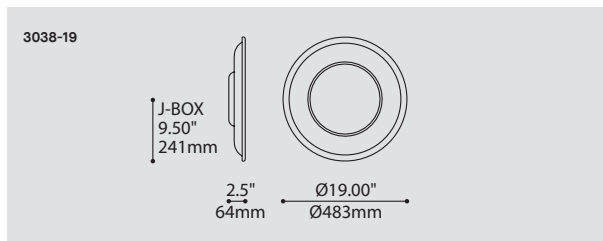

ORDERING SPECIFICATION	SPÉCIFICATION DE COMMANDE	CODE
MODEL MODÈLE		3038-19
3038-19	OSLO	
LIGHT SOURCE SOURCE LUMINEUSE		LED
(WATTAGE, LAMP TYPE, OTHER INFO)		
LED	REGULAR OUTPUT	
COLOR TEMPERATURE TEMPÉRATURE DE COULEUR		
30	3000K	
35	3500K	
40	4000K	
VOLTAGE VOLTAGE		
120V	120 VOLT	
277V	277 VOLT	
DIMMING OPTION OPTION DE GRADATION		
DV	0-10V DIMMING (120-277V)	
DP	PHASE DIMMING (120V ONLY)	
	LED DIMMING DRIVER IS STANDARD IN THIS PRODUCT. PLEASE SPECIFY YOUR DIMMING TYPE.	
DECORATIVE PLATE FINISH FINI PLAQUE DÉCORATIVE		
WHE	WHITE FINE TEXTURE	
ANTE	ANTHRACITE FINE TEXTURE	
SHADE FINISH FINI ABAT-JOUR		
CHF	CHARCOAL FELT	
REF	RED FELT	
SGF	SILVER GRAY FELT	
NBF	NAVY BLUE FELT	

PRODUCT CHARACTERISTICS CARACTÉRISTIQUES DU PRODUIT



- DESIGN:** Now available in two formats, this surface sconce features front and back light giving a nicely toned atmosphere to interior spaces. Made out of formed recycled acoustical PET felt, the shape reminds the effects of rippling water.
- INSTALLATION:** Featuring no visible fasteners, the Oslo installs on a standard junction box with two screws. The front cover is spun in place on the housing.
- LIGHT SOURCE:** Designed with front as well as rear illumination, the Oslo features a LED light source and standard 0-10V or phase dimming.
- SHADE:** Using compression molding to create this beautiful volume, Oslo is available in 4 colours: red, blue, charcoal and silver gray. Made from recycled and recyclable polyester (PET) fibers with characteristics like low VOCs, no formaldehyde, non-irritable and odourless.
- CERTIFIED:** c-CSA-us
- CONCEPTION:** Maintenant offert en deux formats, ce luminaire chaleureux et délicat offre une illumination diffuse et d'ambiance. Fait de feutre acoustique en fibre de PET recyclé, sa forme rappelle l'ondulation de l'eau.
- INSTALLATION:** Avec deux vis non visibles, l'Oslo s'installe simplement sur une boîte de jonction standard. L'abat-jour est ensuite fixé sur l'assemblage en le tournant.
- SOURCE LUMINEUSE:** Offert avec une source DEL à gradation standard 0-10V ou phase qui illumine dans deux directions.
- ABAT-JOUR:** Fabriqué par moulage en compression afin de créer son volume tout en courbes, Oslo est offert en 4 couleurs: rouge, bleu, gris pâle et charbon. Composé de fibres de polyéthylène (PET) recyclées et recyclables avec bas COV, sans formaldéhyde, non irritante et inodore.
- CERTIFIÉ:** c-CSA-us

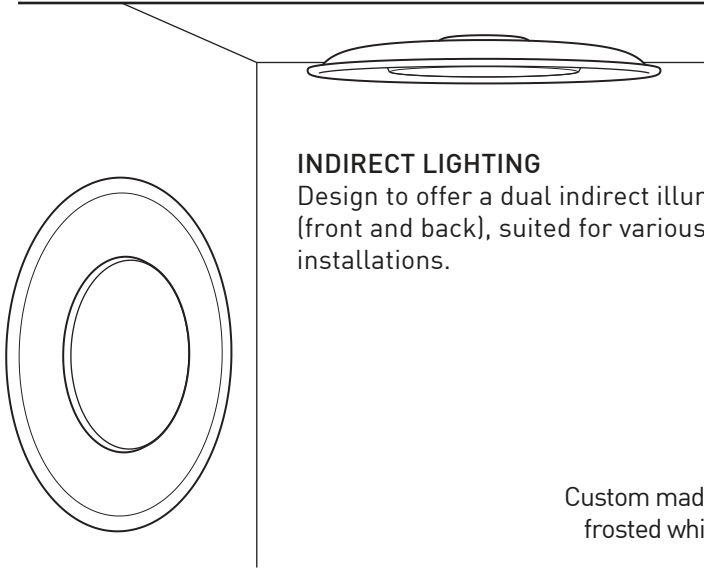

INDIRECT LIGHTING

Design to offer a dual indirect illumination (front and back), suited for various installations.



NOISE REDUCTION

Made with recycled PET, the Oslo custom molded reflector helps tone down noise in your space. Available in Charcoal grey, silver grey or red.

HIGH DIFFUSION
Custom made thermoformed and frosted white PMMA diffuser for a soft and even light.

HIGH PERFORMANCE LED MODULES
Custom made LED ring for a total of 23W (3038-19) or 31W (3038-29).

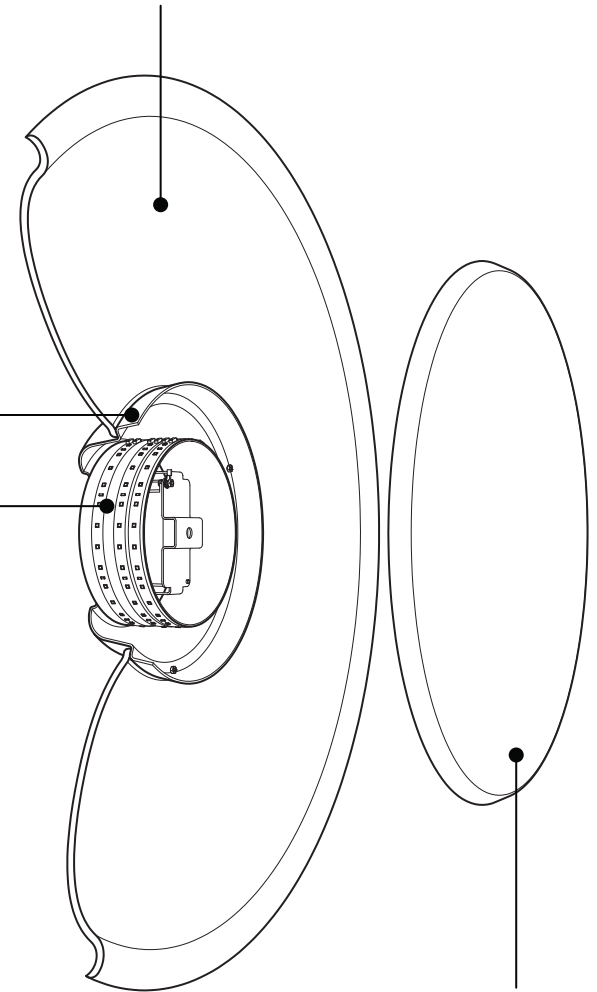

FRONT PLATE

Die-spun steel dish, available in white or black architectural grade fine textured finishes. Outside diameter is Ø11.4in (289mm) for 3038-19 and is Ø16.6in (422mm) for 3038-29.

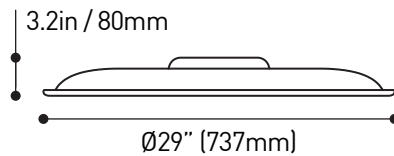
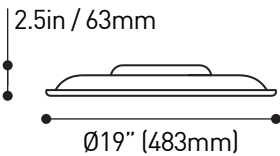

SPECIFICATIONS

LIGHT SOURCE
DELIVERED LUMENS
CRI
LIGHT DISTRIBUTION
DIFFUSOR
STRUCTURE
ACOUSTIC MATERIAL
SHADE
VOLTAGE
DIMMING
WARRANTY

3038-19

Custom LED board - System wattage: 23W
936 [SGF] - 312 [CHF]
83 CRI (typical)
Dual indirect illumination (front and back)
Thermoformed and frosted white PMMA.
Thermoformed dish made of at least 40% recycled polyester (PET) bottles. Available in Charcoal, Silver Grey or Red.
0.75 NRC (acoustic tests in progress)
Die-spun steel dish, available in white or black architectural grade fine textured finishes.
120V (DP) or 120-277V (DV)
Phase dimming (DP) and 0-10V dimming (DV)
5 years

3038-29

Custom LED board - System wattage: 31W
1307 [SGF] - 436 [CHF]
Die-spun steel dish, available in white or black architectural grade fine textured finishes.
120V (DP) or 120-277V (DV)
Phase dimming (DP) and 0-10V dimming (DV)
5 years



225 de Liège Ouest, Suite #200
Montréal (QC), Canada H2P 1H4
Tel : 514.385.3515 Fax : 514.385.4169
www.eurekalighting.com



3038-19
3038-29

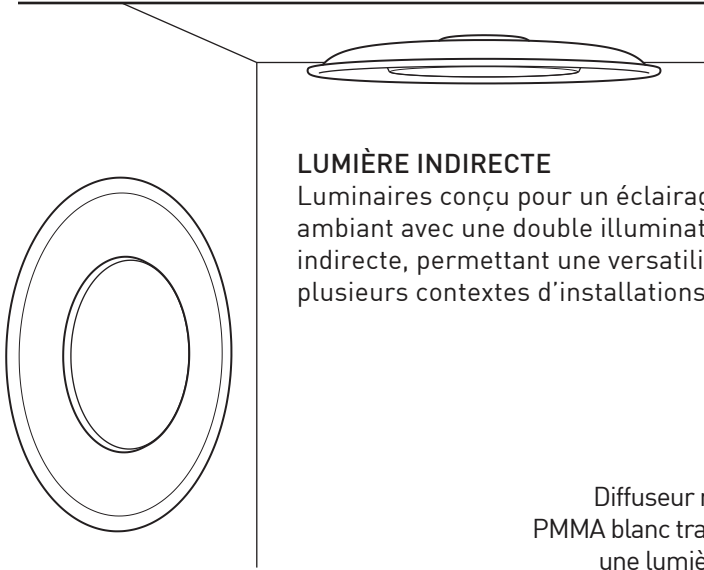

LUMIÈRE INDIRECTE

Luminaires conçu pour un éclairage ambiant avec une double illumination indirecte, permettant une versatilité dans plusieurs contextes d'installations.



ATTÉNUATION DU BRUIT

Avec sa coupole de feutre acoustique en PET recyclé et moulé sur mesure, Oslo améliore l'acoustique de vos espaces. Offert en 3 couleurs: gris charbon, gris argenté ou rouge.

HAUTE DIFFUSION

Diffuseur moulé sur mesure en PMMA blanc translucide et givré pour une lumière douce et uniforme.

MODULE DEL HAUTE PERFORMANCE

Modules DEL (bandes) conçu sur mesure pour un total de 23W (3038-19) ou 31W (3038-29).

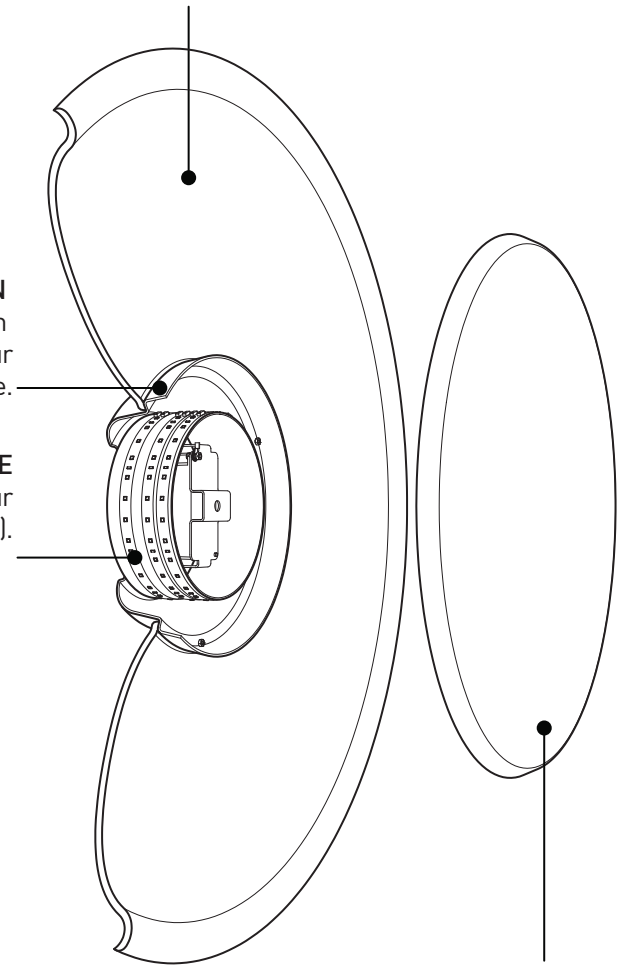

FACADE

Acier repoussé offert avec notre finition architecturale finement texturée blanche ou noire. Le diamètre extérieur est Ø11.4po (289mm) pour 3038-19 et Ø16.6po (422mm) pour 3038-29.

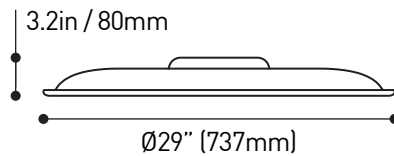
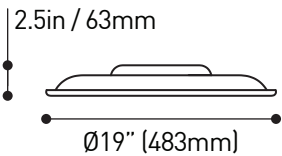

CARACTÉRISTIQUES 3038-19

SOURCE LUMINEUSE	Module DEL sur mesure - Consommation totale: 23W
LUMENS RÉELS	936 [SGF] - 312 [CHF]
IRC	83 CRI (typique)
DISTRIBUTION LUMINEUSE	Double illumination et indirect (avant/arrière).
DIFFUSEUR	PMMA thermoformé et givré.
STRUCTURE	Panneaux acoustiques fait de polyester recyclées (PET). Disponibles en gris charbon, gris argent et rouge.
MATÉRIEL ACOUSTIQUE	0.75 NRC (étude acoustique en cours)
FACÈDE	Acier repoussé, disponible avec notre fini texturé blanc ou anthracite.
VOLTAGE	120V (DP) ou 120-277V (DV)
GRADATION	Gradation "phase" [DP] et gradation "0-10V" [DV]
GARANTIE	5 ans

3038-29

Module DEL sur mesure - Consommation totale: 31W
1307 [SGF] - 436 [CHF]