

AREA 4815X

PROJECT PROJÉT
SPEC TYPE
NOTES



FINISH FINI



BLKE WHE LGE

FAMILY FAMILLE



4715 (WALL SURFACE) 4715 (CEILING SURFACE) 4816X

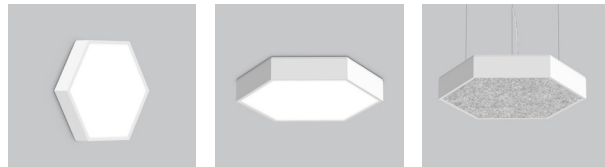

4720 (WALL SURFACE) 4720 (CEILING SURFACE) 4821

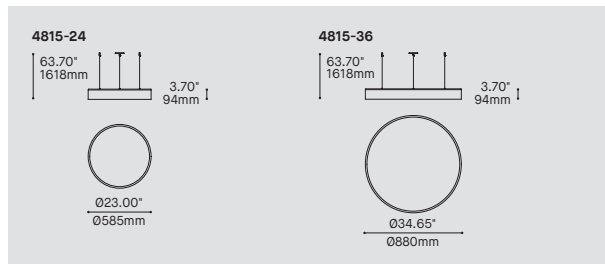

ORDERING SPECIFICATION	SPÉCIFICATION DE COMMANDE	CODE
MODEL MODÈLE		
4815D-24	AREA 24" - DIRECT	
4815D-36	AREA 36" - DIRECT	
4815DI-24	AREA 24" - DIRECT INDIRECT	
4815DI-36	AREA 36" - DIRECT INDIRECT	
LIGHT SOURCE SOURCE LUMINEUSE		
4815D	REGULAR OUTPUT	
LED	REGULAR OUTPUT	
LED.HO	HIGH OUTPUT	
4815DI	REGULAR OUTPUT DIRECT + REGULAR OUTPUT INDIRECT	
LED.C1	HIGH OUTPUT DIRECT + HIGH OUTPUT INDIRECT	
LED.C2	REGULAR OUTPUT DIRECT + HIGH OUTPUT INDIRECT	
LED.C3	HIGH OUTPUT DIRECT + REGULAR OUTPUT INDIRECT	
LED.C4	REGULAR OUTPUT DIRECT + REGULAR OUTPUT INDIRECT	
COLOR TEMPERATURE TEMPÉRATURE DE COULEUR (M)		
27*	2700K	
30	3000K	
35	3500K	
40	4000K	
* LONGER LEAD TIME MAY APPLY, PLEASE CONTACT YOUR EUREKA REPRESENTATIVE		
COLOR RENDERING INDEX (CRI) INDICE DE RENDU DE COULEUR (IRC)		
80	80+ CRI	
90*	90+ CRI	
* LONGER LEAD TIME MAY APPLY, PLEASE CONTACT YOUR EUREKA REPRESENTATIVE		
VOLTAGE VOLTAGE		
120V	120 VOLT	
277V	277 VOLT	
CONTROL OPTION OPTION DE CONTRÔLE		
DV	0-10V DIMMING (120V-277V)	
DP	PHASE DIMMING (120V ONLY)	
NA	NLIGHT AIR CONTROL	
NW	NLIGHT WIRED CONTROL	
LED DIMMING DRIVER IS STANDARD IN THIS PRODUCT, PLEASE SPECIFY YOUR DIMMING TYPE		
EMERGENCY BATTERY BATTERIE D'URGENCE		
EM	EMERGENCY BATTERY	
CABLE CABLE		AC
AC	AIRCRAFT MOUNTING & CLEAR CABLE, FIELD ADJUSTABLE	
CABLE LENGTH LONGUEUR DE CABLE		
60	60" AIRCRAFT CABLE (STD LENGTH)	
**	CUSTOM AIRCRAFT CABLE LENGTH (PLEASE SPECIFY)	
FOR OVERALL LENGTH, PLEASE CONTACT YOUR EUREKA REPRESENTATIVE.		
CANOPY FINISH FINI PAVILLON		
BLKE	BLACK FINE TEXTURE	
WHE	WHITE FINE TEXTURE	
HOUSING FINISH FINI BOITIER		
BLKE	BLACK FINE TEXTURE	
WHE	WHITE FINE TEXTURE	
LGE	LIGHT GRAY FINE TEXTURE	
RAL*	PLEASE SPECIFY RAL CODE	
* LONGER LEAD TIME MAY APPLY, PLEASE CONTACT YOUR EUREKA REPRESENTATIVE		
DIFFUSER FINISH FINI DIFFUSEUR		WH
WH	WHITE	

PRODUCT CHARACTERISTICS CARACTÉRISTIQUES DU PRODUIT



- DESIGN:** Large format, functional and elegant round direct pendants in Ø24" and Ø36". Optional upright modules.
- LIGHT SOURCE:** High performance LED modules with standard 0-10v or phase dimming driver integrated within the fixture.
- STRUCTURE:** Aluminum extrusion frame and die-formed steel backplate with polyester powder finish.
- DIFFUSER:** High performance white translucent PMMA.
- CERTIFIED:** c-CSA-us

AREA 4815

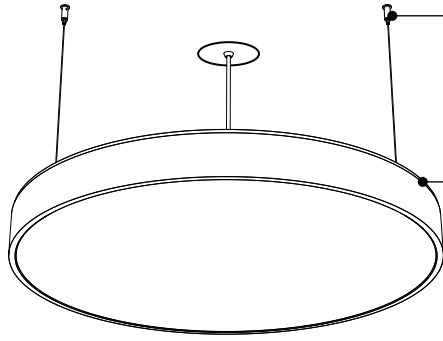

SIMPLIFIED INSTALLATION
Position 3 steel aircraft cables anywhere around a junction box
Easy levelling with adjustable cable grippers

SIMPLE AND CLEAN HOUSING
Precision welded aluminium extrusion
Clean geometry on the outside, structural details on the inside

4815-36 / 4815I-36

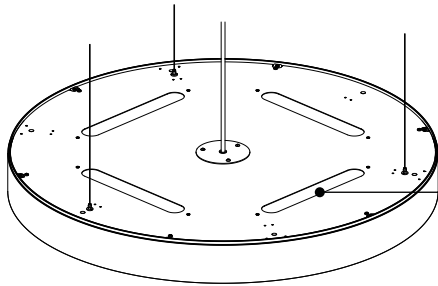

INDIRECT LIGHTING
Dedicated LED indirect lighting modules (4815DI)
Minimum suspension height of 18" (4815DI)
Powder-coated steel covers (4815D)

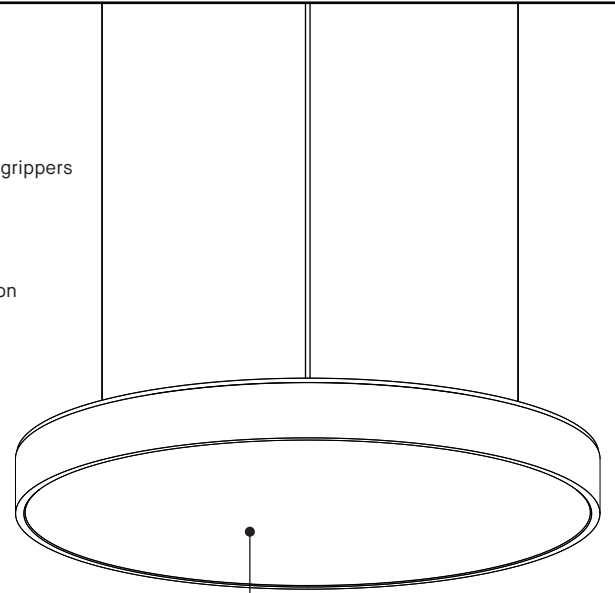

LENS
High performance frosted acrylic lens for superior light transmission

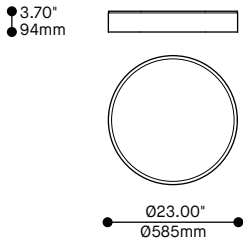

4815-24 / 4815I-24

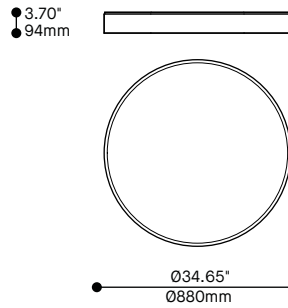

4815-36 / 4815I-36



Also available in acoustic version
See product 4816

PRODUCT SPECIFICATION	4815D-24	4815D-36	4815DI-24	4815DI-36
-----------------------	----------	----------	-----------	-----------

PERFORMANCE				
SYSTEM WATTAGE	35.8W / 44.5W	86.7W / 110.1W	55.5W / 84W	112.2W / 162.3W
DELIVERED DIRECT LUMENS (4000K)	3864LM / 4682LM	9856LM / 12161LM	3864LM / 4682LM	9856LM / 12161LM
DELIVERED INDIRECT LUMENS (4000K)	-	-	2348LM / 4697LM	3089LM / 6179LM
EFFICACY	108LM/W	114LM/W	112LM/W	115LM/W
OTHER INFORMATION				
WEIGHT	15.6LBS / 7.1KG	34.1LBS / 15.5KG	16.5LBS / 7.5KG	35.0LBS / 15.9KG
DUAL CIRCUIT DIMMING	-	-	YES	YES

EFFICACY MULTIPLIERS

CRI	CCT	FACTOR
80+	4000K	1.00
80+	3500K	0.98
80+	3000K	0.94
80+	2700K	0.91
90+	4000K	0.88
90+	3500K	0.85
90+	3000K	0.81
90+	2700K	0.77

LIGHT DISTRIBUTION

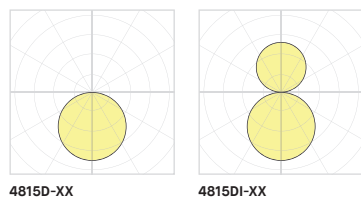

Visit our website for warranty terms and conditions.



TECHNICAL DATA

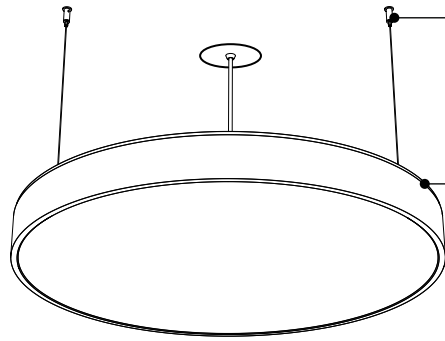

4815-36 / 4815I-36

INSTALLATION SIMPLIFIÉE

Situer les 3 câbles de suspension n'importe où autour de la boîte de connection
Mise à niveau et équilibrage rapide avec serre câbles ajustables

BOÎTIER SOBRE

Extrusion d'aluminium soudée avec précision
Lignes nettes et modernes à l'extérieur, détails structuraux cachés à l'intérieur

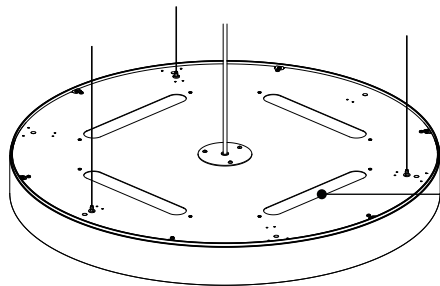

ÉCLAIRAGE INDIRECT

Module LED d'éclairage indirect (4815DI)
Suspension minimum de 18" (4815DI)
Plaquettes en acier peintes (4815D)

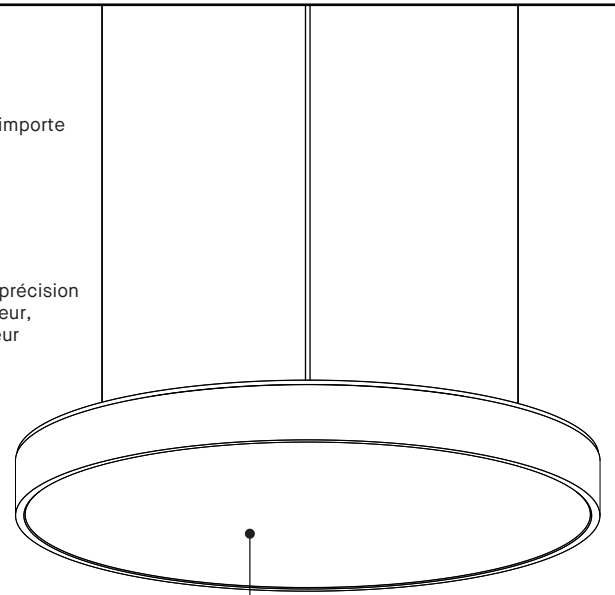

LENTILLE

Lentille d'acrylique givrée haute performance permet une transmission optique supérieure

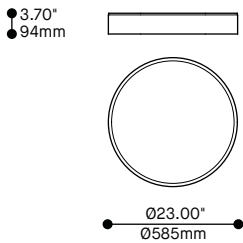

4815-24 / 4815I-24

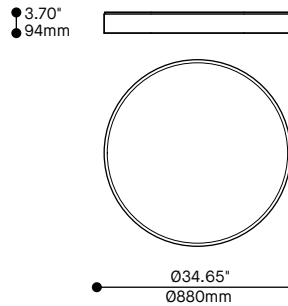

4815-36 / 4815I-36



Aussi disponible en version acoustique
Voir le produit 4816

SPÉCIFICATION PRODUIT

	4815D-24	4815D-36	4815DI-24	4815DI-36
PERFORMANCE				
PUISSANCE TOTALE	35.8W / 44.5W	86.7W / 110.1W	55.5W / 84W	112.2W / 162.3W
LUMENS RÉELS DIRECT (4000K)	3864LM / 4682LM	9856LM / 12161LM	3864LM / 4682LM	9856LM / 12161LM
LUMENS RÉELS INDIRECT (4000K)	-	-	2348LM / 4697LM	3089LM / 6179LM
EFFICACITÉ	108LM/W	114LM/W	112LM/W	115LM/W
AUTRES INFORMATION				
POIDS	15.6LBS / 7.1KG	34.1LBS / 15.5KG	16.5LBS / 7.5KG	35.0LBS / 15.9KG
GRADATION DOUBLE CIRCUIT	-	-	OUI	OUI

FACTEUR D'EFFICACITÉ

IRC	CCT	FACTEUR
80+	4000K	1.00
80+	3500K	0.98
80+	3000K	0.94
80+	2700K	0.91
90+	4000K	0.88
90+	3500K	0.85
90+	3000K	0.81
90+	2700K	0.77

DISTRIBUTION LUMINEUSE

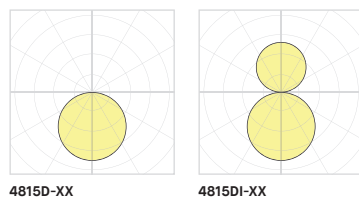

4815D-XX

4815DI-XX



Visitez notre site Web pour les termes et conditions.