

ATOLL - 3852 CEILING

PROJECT PROJÉT
SPEC TYPE
NOTES

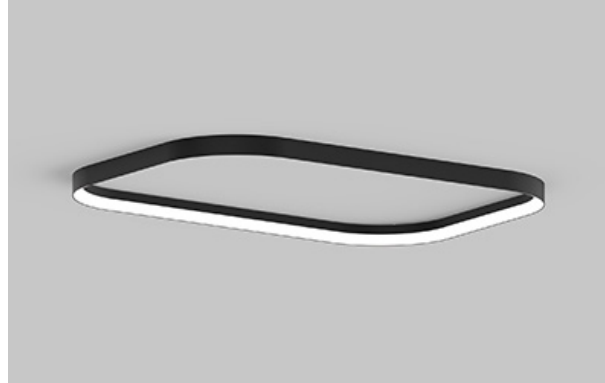

FINISH FINI



FAMILY FAMILLE



DRIVER OPTION OPTION DE PILOTE

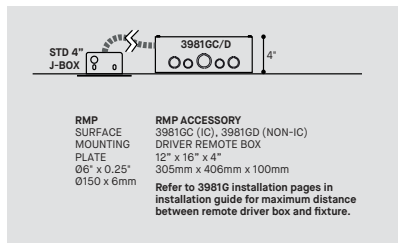

ORDERING SPECIFICATION SPÉCIFICATION DE COMMANDE

CODE

MODEL MODÈLE

3852-44X44	ATOLL SURFACE 44" X 44"
3852-44X62	ATOLL SURFACE 44" X 62"
3852-44X82	ATOLL SURFACE 44" X 82"
3852-44X100	ATOLL SURFACE 44" X 100"
3852-44X120	ATOLL SURFACE 44" X 120"
3852-62X62	ATOLL SURFACE 62" X 62"
3852-62X82	ATOLL SURFACE 62" X 82"
3852-62X100	ATOLL SURFACE 62" X 100"
3852-62X120	ATOLL SURFACE 62" X 120"
3852-82X82	ATOLL SURFACE 82" X 82"
3852-82X100	ATOLL SURFACE 82" X 100"
3852-82X120	ATOLL SURFACE 82" X 120"
3852-100X100	ATOLL SURFACE 100" X 100"
3852-100X120	ATOLL SURFACE 100" X 120"
3852-120X120	ATOLL SURFACE 120" X 120"

LIGHT SOURCE SOURCE LUMINEUSE

LED	REGULAR OUTPUT
LED.HO	HIGH OUTPUT

COLOR TEMPERATURE TEMPÉRATURE DE COULEUR

27	2700K
30	3000K
35	3500K
40*	4000K

* LONGER LEAD TIME MAY APPLY, PLEASE CONTACT YOUR EUREKA REPRESENTATIVE

COLOR RENDERING INDEX (CRI) INDICE DE RENDU DE COULEUR (IRC)

90	90+ CRI	90
----	---------	----

VOLTAGE VOLTAGE

120V	120 VOLT
277V	277 VOLT

CONTROL OPTION OPTION DE CONTRÔLE

DV	0-10V DIMMING (120V-277V)
DP*	PHASE DIMMING (120V ONLY)
NLTAIR2**	NLIGHT AIR CONTROL GEN 2
NLIGHT**	NLIGHT WIRED CONTROL

* ONLY AVAILABLE REGULAR OUTPUT
**CONSULT CANOPY AVAILABILITY CHART AT THE END OF DOCUMENT FOR COMPATIBILITY
**NLIGHT INTEGRATION REQUIRES THE USAGE OF A REMOTE POWER PACK

**LONGER LEAD TIME MAY APPLY, PLEASE CONTACT YOUR EUREKA REPRESENTATIVE
REFER TO NLIGHT GUIDE AND INSTALLATION SHEET FOR ALL REQUIREMENTS

EMERGENCY BATTERY BATTERIE D'URGENCE

EM DRIVER BOX INCLUDED. INSTALLED REMOTELY. SEE EM GUIDE 3981E FOR DETAILS	
EMB*	EMERGENCY BATTERY FOR REMOTE BOX
* 3981EA ACCESSORY IS REQUIRED FOR THIS OPTION	

DRIVER POSITION POSITION DU PILOTE

CONSULT CANOPY AVAILABILITY CHART AT THE END OF DOCUMENT FOR COMPATIBILITY		RMP
RMP	REMOTE DRIVER (REQUIRES ACCESSORY 3981GX)	

CANOPY FINISH FINI PAVILLON

BLKE	BLACK
WHE	WHITE
MATCH*	COLOR MATCH WITH RING FINISH

* LONGER LEAD TIME MAY APPLY, PLEASE CONTACT YOUR EUREKA REPRESENTATIVE

FINISH FINI

BLKE	BLACK	HGE*	HUNTER GREEN
WHE	WHITE	LNE*	LUNAR GREY
AYE*	APRICOT YELLOW	NBE*	NAVY BLUE
BRE*	BRICK RED	SBE*	SAND BEIGE
CBE*	CHOCOLATE BROWN	SGE*	SAGE GREY
CPE*	CLAY PINK	STE*	SUMMER TEAL
DBE*	DYNAMIC BLUE	RAL**	PLEASE SPECIFY RAL CODE
GGE*	GRASS GREEN		

* LONGER LEAD TIME MAY APPLY, PLEASE CONTACT YOUR EUREKA REPRESENTATIVE.
** SPECIFY 4 DIGIT RAL CLASSIC CODE. LONGER LEAD TIME MAY APPLY, PLEASE CONTACT YOUR EUREKA REPRESENTATIVE.

ACCESSORY ACCESSOIRE

CONSULT CANOPY AVAILABILITY CHART AT THE END OF DOCUMENT FOR COMPATIBILITY	
3981GC	DRIVER BOX FOR REMOTE INSTALLATION - 4" X 12" X 16"
3981GD1	1 NON-IC 120V ONLY DRIVER BOX FOR REMOTE INSTALLATION - 4" X 12" X 16"
3981GD2	1 NON-IC 277V ONLY DRIVER BOX FOR REMOTE INSTALLATION - 4" X 12" X 16"
39NLAA	NLIGHT AIR GEN 2 REMOTE POWER PACK
39NLWA	NLIGHT WIRED REMOTE POWER PACK

ACCESSORY EMERGENCY BATTERY ACCESSOIRE BATTERIE D'URGENCE

3981EA	ELECTRICAL BOX FOR EMB EMERGENCY BATTERY
--------	--

ATOLL - 3852 CEILING - TUNABLE WHITE

PROJECT PROJÉT
SPEC TYPE
NOTES

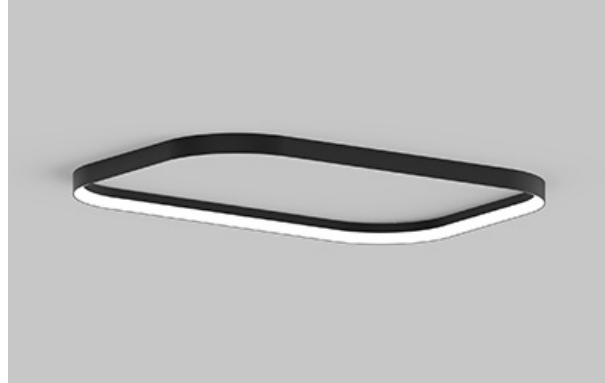

FINISH FINI



FAMILY FAMILLE



DRIVER OPTION OPTION DE PILOTE

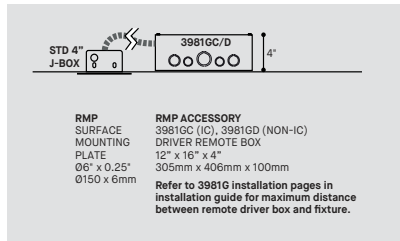

ORDERING SPECIFICATION SPÉCIFICATION DE COMMANDE

MODEL MODÈLE		CODE
3852-44X44	ATOLL SURFACE 44" X 44"	
3852-44X62	ATOLL SURFACE 44" X 62"	
3852-44X82	ATOLL SURFACE 44" X 82"	
3852-44X100	ATOLL SURFACE 44" X 100"	
3852-44X120	ATOLL SURFACE 44" X 120"	
3852-62X62	ATOLL SURFACE 62" X 62"	
3852-62X82	ATOLL SURFACE 62" X 82"	
3852-62X100	ATOLL SURFACE 62" X 100"	
3852-62X120	ATOLL SURFACE 62" X 120"	
3852-82X82	ATOLL SURFACE 82" X 82"	
3852-82X100	ATOLL SURFACE 82" X 100"	
3852-82X120	ATOLL SURFACE 82" X 120"	
3852-100X100	ATOLL SURFACE 100" X 100"	
3852-100X120	ATOLL SURFACE 100" X 120"	
3852-120X120	ATOLL SURFACE 120" X 120"	

LIGHT SOURCE SOURCE LUMINEUSE		
LED	REGULAR OUTPUT	
LED.HO	HIGH OUTPUT	

COLOR TEMPERATURE TEMPÉRATURE DE COULEUR		TW
TW*	TUNABLE WHITE (2700K TO 5000K)	
	*LONGER LEAD TIME MAY APPLY, PLEASE CONTACT YOUR EUREKA REPRESENTATIVE	

COLOR RENDERING INDEX (CRI) INDICE DE RENDU DE COULEUR (IRC)		80
80	80+ CRI	

VOLTAGE VOLTAGE		
120V	120 VOLT	
277V	277 VOLT	

CONTROL OPTION OPTION DE CONTRÔLE		
DDV	DUAL 0-10V DIMMING	
NLT*	NIGHT NTUNE CONTROL (NOT AVAILABLE FOR HO OUTPUT)	
	*LONGER LEAD TIME MAY APPLY, PLEASE CONTACT YOUR EUREKA REPRESENTATIVE	
	*REFER TO NLIGHT GUIDE AND INSTALLATION SHEET FOR ALL REQUIREMENTS	

DRIVER POSITION POSITION DU PILOTE		RMP
	CONSULT CANOPY AVAILABILITY CHART AT THE END OF DOCUMENT FOR COMPATIBILITY	
RMP	REMOTE DRIVER (REQUIRES ACCESSORY 3981GX)	

CANOPY FINISH FINI PAVILLON		
BLKE	BLACK	
WHE	WHITE	
MATCH*	COLOR MATCH WITH RING FINISH	
	* LONGER LEAD TIME MAY APPLY, PLEASE CONTACT YOUR EUREKA REPRESENTATIVE	

RING FINI			
BLKE	BLACK	HGE*	HUNTER GREEN
WHE	WHITE	LNE*	LUNAR GREY
AYE*	APRICOT YELLOW	NBE*	NAVY BLUE
BRE*	BRICK RED	SBE*	SAND BEIGE
CBE*	CHOCOLATE BROWN	SGE*	SAGE GREY
CPE*	CLAY PINK	STE*	SUMMER TEAL
DBE*	DYNAMIC BLUE	RAL**	PLEASE SPECIFY RAL CODE
GGE*	GRASS GREEN		
	* LONGER LEAD TIME MAY APPLY, PLEASE CONTACT YOUR EUREKA REPRESENTATIVE.		
	** SPECIFY 4 DIGIT RAL CLASSIC CODE. LONGER LEAD TIME MAY APPLY, PLEASE CONTACT YOUR EUREKA REPRESENTATIVE.		

ACCESSORY ACCESSOIRE		
3981GC	DRIVER BOX FOR REMOTE INSTALLATION - 4" X 12" X 16"	
3981GD1	1 NON-IC 120V ONLY DRIVER BOX FOR REMOTE INSTALLATION - 4" X 12" X 16"	
3981GD2	1 NON-IC 277V ONLY DRIVER BOX FOR REMOTE INSTALLATION - 4" X 12" X 16"	

PRODUCT CHARACTERISTICS CARACTÉRISTIQUES DU PRODUIT



ATOLL - 3852 - DIMENSIONS

HEIGHT OF THE PROFILE : 3" / 74mm

WIDTH OF THE PROFILE : 1.4" / 35mm

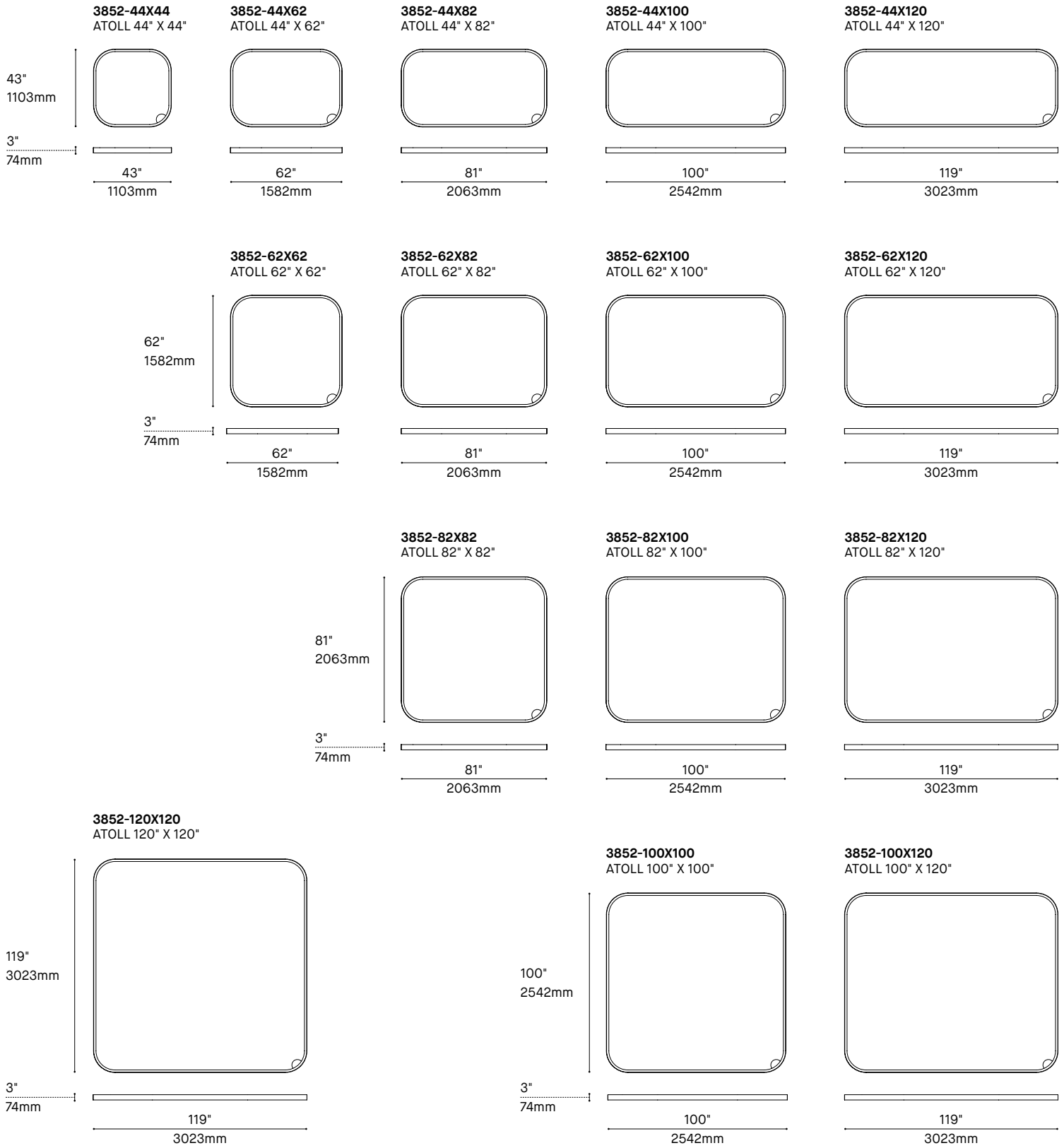

ATOLL 4352 - WALL & CEILING

LARGE FAMILY

Offered in 15 different sizes.
An infinite number of possible layouts.
From the smallest to the largest space.

HIGH PERFORMANCE

LED illumination is controlled by 98% efficient reflectors, giving the ATOLL excellent optical and energy performance.
Combined with its highly efficient silicone lens ensures high-performance and comfortable lighting.

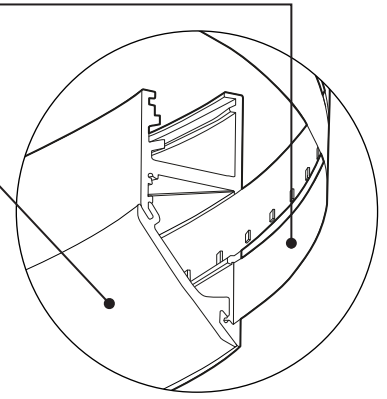
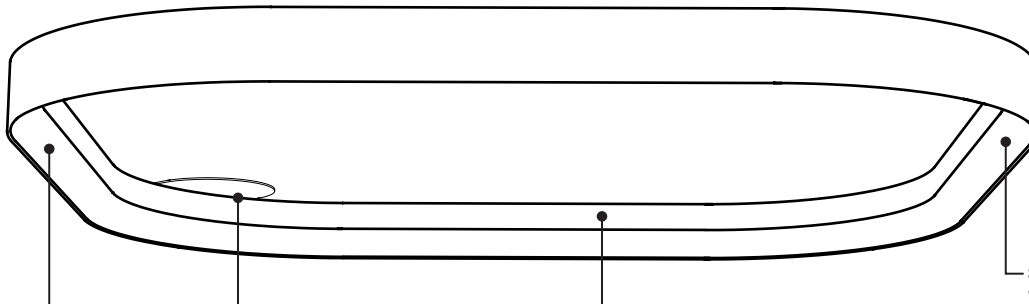

COVER PLATE

Atoll is supplied with a standard 4" junction box an elegant installation color matched cover plate for an elegant installation.

RING FINISH OPTIONS

Sturdy rolled aluminum extrusion available in 14 textured powder coat finishes as well as RAL custom colors also available on demand.

SILICONE DIFFUSER

With anti-yellowing agents and is UV stable. Allows for a single discreet joining line across all sizes.

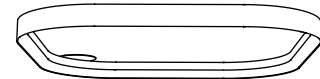

MINIMAL SURFACE MOUNTING

With a depth of 2.9" Atoll is ADA compliant when installed on a wall.

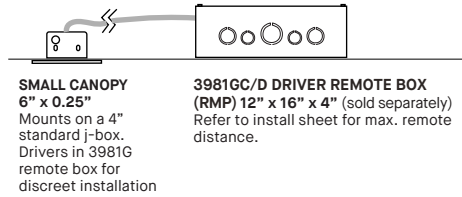
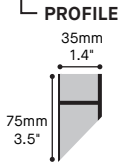

PRODUCT SPECIFICATION	44X44		44X62		44X81		44X100		44X120		62X62		62X82		62X100	
PERFORMANCE (4000K)	REG	HO	REG	HO	REG	HO	REG	HO	REG	HO	REG	HO	REG	HO	REG	HO
WATTAGE - DIRECT	39.0W	79.2W	48.7W	99.6W	56.7W	120W	74.9W	158.4W	74.9W	158.4W	56.7W	120W	66.9W	141.5W	74.9W	158.4W
DELIVERED LUMENS	3807LM	7215LM	4758LM	9065LM	5553LM	10916LM	7339LM	14429LM	7339LM	14429LM	5553LM	10916LM	6544LM	12860LM	7339LM	14429LM
EFFICACY	98LM/W	91LM/W	98LM/W	91LM/W	98LM/W	91LM/W	98LM/W	91LM/W	98LM/W	91LM/W	98LM/W	91LM/W	98LM/W	91LM/W	98LM/W	91LM/W
OTHER INFORMATION	16.2LBS / 7.4KG		20LBS / 9.1KG		23.8LBS / 10.8KG		27.6LBS / 12.5KG		31.4LBS / 14.3KG		23.8LBS / 10.8KG		27.6LBS / 12.5KG		31.4LBS / 14.3KG	
L70 (LUMEN MAINTENANCE)	> 60 000 H		> 60 000 H		> 60 000 H		> 60 000 H		> 60 000 H		> 60 000 H		> 60 000 H		> 60 000 H	

PRODUCT SPECIFICATION	62X120		82X82		81X100		82X120		100X100		100X120		120X120	
PERFORMANCE (4000K)	REG	HO	REG	HO	REG	HO	REG	HO	REG	HO	REG	HO	REG	HO
WATTAGE - DIRECT	85.1W	179.9W	74.9W	158.4W	80.8W	180W	88.9W	187.4W	88.9W	187.4W	93.7W	197.3W	96.4W	202.6W
DELIVERED LUMENS	8330LM	16374LM	7339LM	14429LM	7938LM	16374LM	8733LM	17192LM	8733LM	17192LM	9233LM	18194LM	9536LM	18816LM
EFFICACY	98LM/W	91LM/W	98LM/W	91LM/W	98LM/W	91LM/W	98LM/W	92LM/W	98LM/W	92LM/W	99LM/W	91LM/W	99LM/W	93LM/W
OTHER INFORMATION	35.2LBS / 16KG		31.4LBS / 14.3KG		35.2LBS / 16KG		39LBS / 17.7KG		39LBS / 17.7KG		42.8LBS / 19.5KG		46.6LBS / 21.2KG	
L70 (LUMEN MAINTENANCE)	> 60 000 H		> 60 000 H		> 60 000 H		> 60 000 H		> 60 000 H		> 60 000 H		> 60 000 H	

EFFICACY MULTIPLIERS

CRIC	CT	FACTOR	TW FACTOR
80+	5000K	-	0.93
80+	4000K	-	1.00
80+	3500K	-	0.99
80+	3000K	-	0.98
80+	2700K	-	0.91
90+	4000K	1.00	-
90+	3500K	0.96	-
90+	3000K	0.92	-
90+	2700K	0.87	-

LIGHT DISTRIBUTION

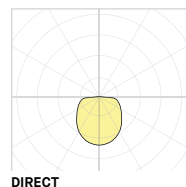

Visit our website for warranty terms and conditions.



TECHNICAL DATA

ATOLL 3852 - MURAL & PLAFOND

FAMILLE ÉTENDUE

Offert en 15 tailles polyvalentes.
Une infinité de combinaisons possibles.
Pour les petits aux plus grands espaces.

HAUTE PERFORMANCE

La lumière des bandes DEL est contrôlée par des réflecteurs efficaces à 98%, ce qui confère à l'ATOLL d'excellentes performances optiques et énergétiques. Sa lentille en silicone très efficace assure un éclairage performant et confortable.

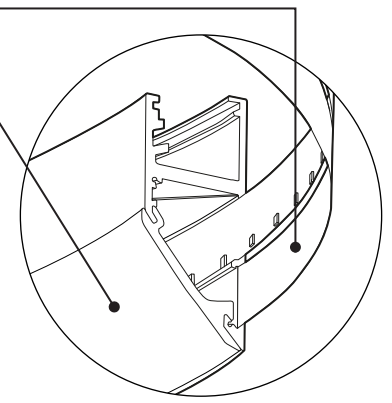
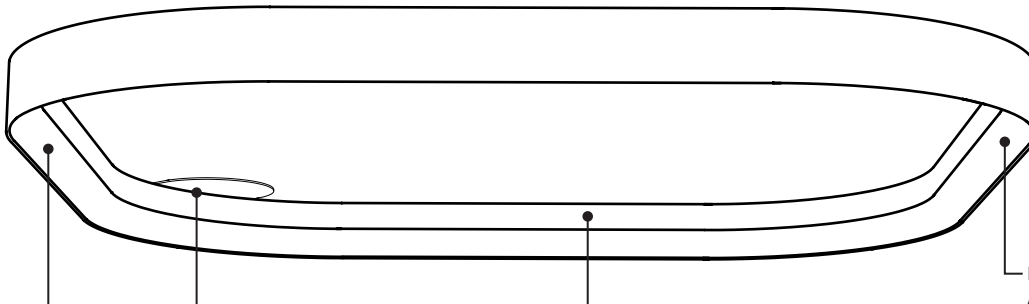

COUVERT DE BOÎTE ÉLECTRIQUE

Atoll est fourni avec un couvercle avec la même finition que le profil pour une installation élégante sur une boîte de jonction standard de 4".

OPTIONS POUR FINITION DES ANNEAUX

Profilé en aluminium robuste, finition en poudre texturée de qualité supérieur disponible en 14 couleurs. Couleurs personnalisées RAL disponibles sur demande.

DIFFUSEUR EN SILICONE

Avec agents anti-jaunissement et une stabilité aux rayons UV. Permet d'avoir une seule ligne de joint discrète pour toutes les grandeurs.

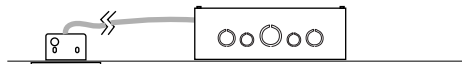
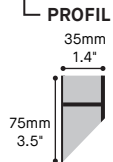

PETIT PAVILLON
6" x 0.25"
Installation minimale sur une boîte 4" standard.
Doit être combiné à la boîte à distance 3981G.

BOÎTE PILOTES À DISTANCE (RMP) 3981G
(vendue séparément)
12" x 16" x 4" Se référer à la fiche d'installation pour la distance maximale d'éloignement.

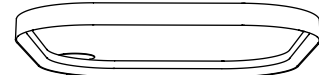

MONTAGE SURFACE MINIMALE

Avec une profondeur de 2.9" Atoll est conforme à la norme ADA lorsqu'installé au mur.

SPÉCIFICATION PRODUIT	44X44		44X62		44X81		44X100		44X120		62X62		62X82		62X100	
PERFORMANCE (4000K)	REG	HO	REG	HO	REG	HO	REG	HO	REG	HO	REG	HO	REG	HO	REG	HO
PUISSANCE DIRECT	39.0W	79.2W	48.7W	99.6W	56.7W	120W	74.9W	158.4W	74.9W	158.4W	56.7W	120W	66.9W	141.5W	74.9W	158.4W
UMENS RÉELS DIRECT (4000K)	3807LM	7215LM	4758LM	9065LM	5553LM	10916LM	7339LM	14429LM	7339LM	14429LM	5553LM	10916LM	6544LM	12860LM	7339LM	14429LM
EFFICACITÉ DIRECT	98LM/W	91LM/W	98LM/W	91LM/W	98LM/W	91LM/W	98LM/W	91LM/W	98LM/W	91LM/W	98LM/W	91LM/W	98LM/W	91LM/W	98LM/W	91LM/W
OTHER AUTRES INFORMATIONS	16.2LBS / 7.4KG		20LBS / 9.1KG		23.8LBS / 10.8KG		27.6LBS / 12.5KG		31.4LBS / 14.3KG		23.8LBS / 10.8KG		27.6LBS / 12.5KG		31.4LBS / 14.3KG	
L70 (MAINTENANCE DE LA LUMIÈRE)	> 60 000 H		> 60 000 H		> 60 000 H		> 60 000 H		> 60 000 H		> 60 000 H		> 60 000 H		> 60 000 H	

SPÉCIFICATION PRODUIT	62X120		82X82		81X100		82X120		100X100		100X120		120X120	
PERFORMANCE (4000K)	REG	HO	REG	HO	REG	HO	REG	HO	REG	HO	REG	HO	REG	HO
PUISSANCE DIRECT	85.1W	179.9W	74.9W	158.4W	80.8W	180W	88.9W	187.4W	88.9W	187.4W	93.7W	197.3W	96.4W	202.6W
UMENS RÉELS DIRECT (4000K)	8330LM	16374LM	7339LM	14429LM	7938LM	16374LM	8733LM	17192LM	8733LM	17192LM	9233LM	18194LM	9536LM	18816LM
EFFICACITÉ DIRECT	98LM/W	91LM/W	98LM/W	91LM/W	98LM/W	91LM/W	98LM/W	92LM/W	98LM/W	92LM/W	99LM/W	91LM/W	99LM/W	93LM/W
OTHER AUTRES INFORMATIONS	35.2LBS / 16KG		31.4LBS / 14.3KG		35.2LBS / 16KG		39LBS / 17.7KG		39LBS / 17.7KG		42.8LBS / 19.5KG		46.6LBS / 21.2KG	
L70 (MAINTENANCE DE LA LUMIÈRE)	> 60 000 H		> 60 000 H		> 60 000 H		> 60 000 H		> 60 000 H		> 60 000 H		> 60 000 H	

FACTEUR D'EFFICACITÉ

CRIC	CT	FACTOR	TW FACTOR
80+	5000K	-	0.93
80+	4000K	-	1.00
80+	3500K	-	0.99
80+	3000K	-	0.98
80+	2700K	-	0.91
90+	4000K	1.00	-
90+	3500K	0.96	-
90+	3000K	0.92	-
90+	2700K	0.87	-

DISTRIBUTION LUMINEUSE

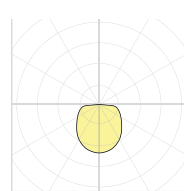

DIRECTE



Visitez notre site Web pour les termes et conditions.





DONNÉES TECHNIQUES

ATOLL - 4852 DIRECT, 3852/3853 SURFACE : CANOPY COMPATIBILITY CHART

DD : DUAL 0-10V DIMMING CONTROL FOR TUNABLE WHITE
 NT : NTUNE WIRELESS CONTROL FOR TUNABLE WHITE
 DP : PHASE DIMMING

BLANK SPACE = NOT AVAILABLE
 HO-REG OR REG-HO ARE EQUIVALENT IN THE CHART BELOW
 IC / NON-IC : NON-IC REMOTE BOXES CANNOT BE IN CONTACT WITHIN 3" OF INSULATION

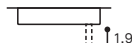
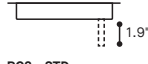
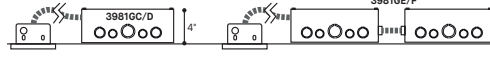
 FIXTURE DIMENSIONS D = DIRECT, I = INDIRECT ILLUMINANCE : REG OR HO	PHASE DIMMING OPTION	CANOPY								
		RC1	RC2	RC3			RC5 (RMP)			
		 RC1 Ø5.50" x 1.35" Ø140 x 34.3mm*	 RC2 - WIRED / AIR Ø7.75" x 1.30" Ø196.9 x 33mm*	 RC3 - STD RC3 - WIRED / AIR Ø9.4" x 1.88" Ø238.8 x 47.8mm*			 RC5 (RMP) 247IC Ø4.5" x 0.5" Ø114 x 13mm		RC5 (RMP) ACCESSORY 3981GC (IC), 3981GD (NON-IC) DRIVER REMOTE BOX 12" x 16" x 4" 305mm x 406mm x 100mm	
STANDARD COMPACT CANOPY	NLIGHT WIRED OR AIR COMPACT CANOPY	STD HIGHER POWER	TUNABLE WHITE	NLIGHT WIRED OR AIR	FOR REMOTE LOCATION OR CAN BE REQUIRED TO FIT HIGHER POWER OR NLIGHT IF NOT AVAILABLE IN RC1,2,3,4		NLIGHT WIRED	TUNABLE WHITE		
44X44 D - REG	DP	✓	✓		DD+NT		3981GC	✓	DD/NT	
44X44 D - HO				✓	DD		3981GC	✓	DD	
44X62 D - REG	DP	✓	✓		DD+NT		3981GC	✓	DD/NT	
44X62 D - HO				✓	DD		3981GC	✓	DD	
44X81 D - REG	DP			✓	DD+NT	✓	3981GC	✓	DD/NT	
44X81 D - HO	DP			✓	DD	✓	3981GC	✓	DD	
44X100 D - REG				✓	DD+NT		3981GC	✓	DD/NT	
44X100 D - HO				✓	DD		3981GC	✓	DD	
44X120 D - REG				✓	DD+NT		3981GC	✓	DD/NT	
44X120 D - HO				✓	DD		3981GC	✓	DD	
62X62 D - REG	DP			✓	DD+NT	✓	3981GC	✓	DD/NT	
62X62 D - HO	DP			✓	DD	✓	3981GC	✓	DD	
62X81 D - REG				✓	DD+NT		3981GC	✓	DD/NT	
62X81 D - HO				✓	DD		3981GC	✓	DD	
62X100 D - REG				✓	DD+NT		3981GC	✓	DD/NT	
62X100 D - HO				✓	DD		3981GC	✓	DD	
62X120 D - REG				✓	DD		3981GC	✓	DD	
62X120 D - HO				✓			NON-IC : 3981GD1 (120V) / 3981GD2 (277V)	✓		
81X81 D - REG				✓	DD+NT		3981GC	✓	DD/NT	
81X81 D - HO				✓	DDV		3981GC	✓	DD	
81X100 D - REG				✓	DD		3981GC	✓	DD	
81X100 D - HO				✓			NON-IC : 3981GD1 (120V) / 3981GD2 (277V)	✓		
81X120 D - REG				✓	DD		3981GC	✓	DD	
81X120 D - HO				✓			NON-IC : 3981GD1 (120V) / 3981GD2 (277V)	✓		
100X100 D - REG				✓	DD		3981GC	✓	DD	
100X100 D - HO				✓			NON-IC : 3981GD1 (120V) / 3981GD2 (277V)	✓		
100X120 D - REG				✓	DD		3981GC	✓	DD	
100X120 D - HO				✓			NON-IC : 3981GD1 (120V) / 3981GD2 (277V)	✓		
120X120 D - REG				✓	DD		3981GC	✓	DD	
120X120 D - HO				✓			NON-IC : 3981GD1 (120V) / 3981GD2 (277V)	✓		



SPECIFICATION