

# ATOLL SQUARE & RECTANGLE - 3853 CEILING

PROJECT PROJCT
SPEC TYPE
NOTES

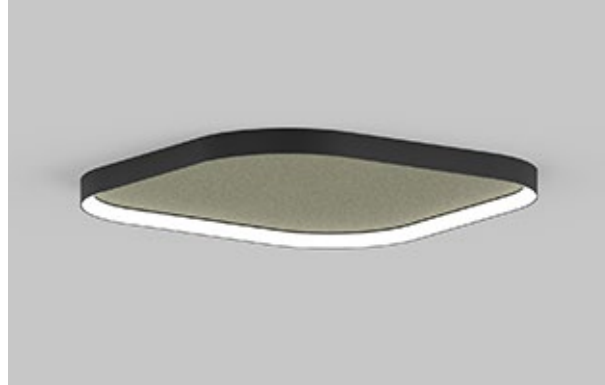

## FINISH FINI



## FAMILY FAMILLE



## DRIVER OPTION OPTION DE PILOTE

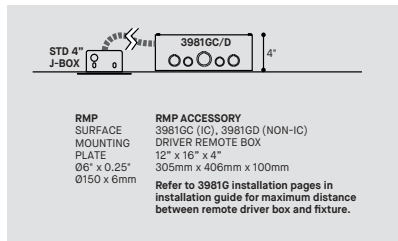

## ORDERING SPECIFICATION SPÉCIFICATION DE COMMANDE

CODE

### MODEL MODÈLE

3853-44X44	ATOLL ACOUSTIC 44" X 44"
3853-44X62	ATOLL ACOUSTIC 44" X 62"
3853-44X82	ATOLL ACOUSTIC 44" X 82"
3853-44X100	ATOLL ACOUSTIC 44" X 100" (SECTIONAL PANELS)
3853-44X120	ATOLL ACOUSTIC 44" X 120" (SECTIONAL PANELS)
3853-62X62	ATOLL ACOUSTIC 62" X 62" (SECTIONAL PANELS)
3853-62X82	ATOLL ACOUSTIC 62" X 82" (SECTIONAL PANELS)
3853-62X100	ATOLL ACOUSTIC 62" X 100" (SECTIONAL PANELS)
3853-62X120	ATOLL ACOUSTIC 62" X 120" (SECTIONAL PANELS)
3853-82X82	ATOLL ACOUSTIC 82" X 82" (SECTIONAL PANELS)
3853-82X100	ATOLL ACOUSTIC 82" X 100" (SECTIONAL PANELS)
3853-82X120	ATOLL ACOUSTIC 82" X 120" (SECTIONAL PANELS)

### LIGHT SOURCE SOURCE LUMINEUSE

LED	REGULAR OUTPUT
LED.HO	HIGH OUTPUT

### COLOR TEMPERATURE TEMPÉRATURE DE COULEUR

27	2700K
30	3000K
35	3500K
40*	4000K

\* LONGER LEAD TIME MAY APPLY. PLEASE CONTACT YOUR EUREKA REPRESENTATIVE

### COLOR RENDERING INDEX (CRI) INDICE DE RENDU DE COULEUR (IRC)

90	90+ CRI	90
----	---------	----

### VOLTAGE VOLTAGE

120V	120 VOLT
277V	277 VOLT

### CONTROL OPTION OPTION DE CONTRÔLE

DV	0-10V DIMMING (120V-277V)
DP*	PHASE DIMMING (120V ONLY)
NLTAIR2**	NLIGHT AIR CONTROL GEN 2
NLIGHT**	NLIGHT WIRED CONTROL

\*ONLY AVAILABLE REGULAR OUTPUT  
 \*\*CONSULT CANOPY AVAILABILITY CHART AT THE END OF DOCUMENT FOR COMPATIBILITY  
 \*\*NLIGHT INTEGRATION REQUIRES THE USAGE OF A REMOTE POWER PACK  
 \*\*NLIGHT AIR IS NOT AVAILABLE WITH RMP DRIVER POSITION  
 \*\*LONGER LEAD TIME MAY APPLY. PLEASE CONTACT YOUR EUREKA REPRESENTATIVE  
 REFER TO NLIGHT GUIDE AND INSTALLATION SHEET FOR ALL REQUIREMENTS

### EMERGENCY BATTERY BATTERIE D'URGENCE

EM DRIVER BOX INCLUDED. INSTALLED REMOTELY. SEE EM GUIDE 3981E FOR DETAILS

EMB*	EMERGENCY BATTERY FOR REMOTE BOX
------	----------------------------------

\* 3981EA ACCESSORY IS REQUIRED FOR THIS OPTION

### DRIVER POSITION POSITION DU PILOTE

CONSULT CANOPY AVAILABILITY CHART AT THE END OF DOCUMENT FOR COMPATIBILITY

RMP	REMOTE DRIVER (REQUIRES ACCESSORY 3981GX)	RMP
-----	---	-----

### CANOPY FINISH FINI PAVILLON

BLKE	BLACK
WHE	WHITE
MATCH*	COLOR MATCH WITH RING FINISH

\* LONGER LEAD TIME MAY APPLY. PLEASE CONTACT YOUR EUREKA REPRESENTATIVE

### FINISH FINI

BLKE	BLACK	HGE*	HUNTER GREEN
WHE	WHITE	LNE*	LUNAR GREY
AYE*	APRICOT YELLOW	NBE*	NAVY BLUE
BRE*	BRICK RED	SBE*	SAND BEIGE
CBE*	CHOCOLATE BROWN	SGE*	SAGE GREY
CPE*	CLAY PINK	STE*	SUMMER TEAL
DBE*	DYNAMIC BLUE	RAL**	PLEASE SPECIFY RAL CODE
GGE*	GRASS GREEN		

\* LONGER LEAD TIME MAY APPLY. PLEASE CONTACT YOUR EUREKA REPRESENTATIVE.  
 \*\* SPECIFY 4 DIGIT RAL CLASSIC CODE. LONGER LEAD TIME MAY APPLY. PLEASE CONTACT YOUR EUREKA REPRESENTATIVE.

# ATOLL SQUARE & RECTANGLE - 3853 CEILING

## FELT FINISH OPTIONS OPTIONS DE FINI FEUTRE

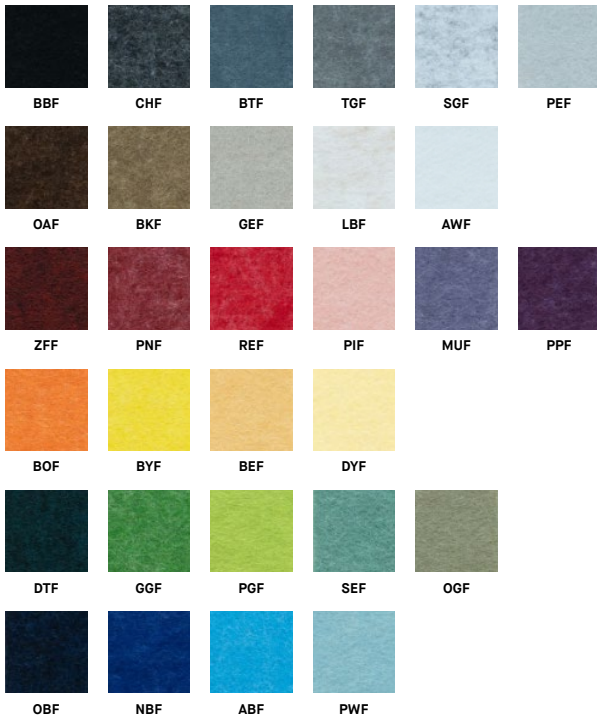

## ORDERING SPECIFICATION SPÉCIFICATION DE COMMANDE

## CODE

### FELT FINISH FINI FEUTRE

<b>BBF</b>	BASIC BLACK	<b>MUF</b>	MYSTIC MULBERRY
<b>CHF</b>	CHARCOAL	<b>PPF</b>	PLUM PURPLE
<b>BTF</b>	BATTLESHIP	<b>BOF</b>	BLOOD ORANGE
<b>TGF</b>	TITANIUM GRAY	<b>BYF</b>	BANANA YELLOW
<b>SGF</b>	SILVER GRAY	<b>BEF</b>	BUTTERSCOTCH
<b>PEF</b>	PEBBLE GRAY	<b>DYF</b>	DAISY YELLOW
<b>AWF</b>	ARTIC WHITE	<b>DTF</b>	DEEP TEAL GREEN
<b>OAF</b>	OAK BROWN	<b>GGF</b>	GRASS GREEN
<b>BKF</b>	BARK BROWN	<b>PGF</b>	PEAR GREEN
<b>GEF</b>	GREIGE	<b>SEF</b>	SEAFOAM
<b>LBF</b>	LIGHT BEIGE	<b>OGF</b>	OLIVE GREEN
<b>ZFF</b>	ZINFANDEL	<b>OBF</b>	OCEAN BLUE
<b>PNF</b>	PINOT NOIR	<b>NBF</b>	NAVY BLUE
<b>REF</b>	RED	<b>ABF</b>	AZURE BLUE
<b>PIF</b>	PETAL PINK	<b>PWF</b>	POWDER BLUE

### ACCESSORY ACCESSOIRE

CONSULT CANOPY AVAILABILITY CHART AT THE END OF DOCUMENT FOR COMPATIBILITY

<b>3981GC</b>	DRIVER BOX FOR REMOTE INSTALLATION - 3.83" X 12" X 16"
<b>3981GD1</b>	1 NON-IC 120V ONLY DRIVER BOX FOR REMOTE INSTALLATION - 4" X 12" X 16"
<b>3981GD2</b>	1 NON-IC 277V ONLY DRIVER BOX FOR REMOTE INSTALLATION - 4" X 12" X 16"
<b>39NLAA</b>	NLIGHT AIR GEN 2 REMOTE POWER PACK
<b>39NLWA</b>	NLIGHT WIRED REMOTE POWER PACK

### ACCESSORY EMERGENCY BATTERY ACCESSOIRE BATTERIE D'URGENCE

<b>3981EA</b>	ELECTRICAL BOX FOR EMB EMERGENCY BATTERY
---------------	--

## PRODUCT CHARACTERISTICS CARACTÉRISTIQUES DU PRODUIT



# ATOLL SQUARE & RECTANGLE - 3853 CEILING - TUNABLE WHITE

PROJECT PROJCT

SPEC TYPE

NOTES

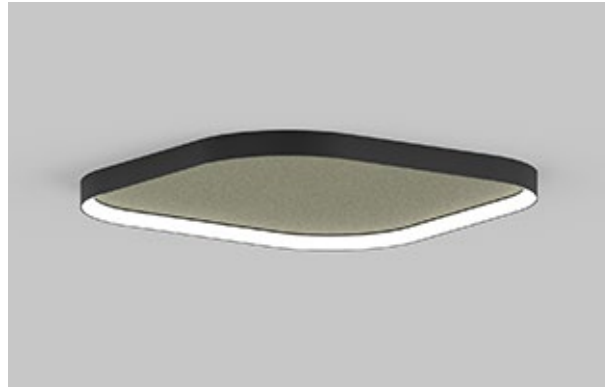

## FINISH FINI



## FAMILY FAMILLE

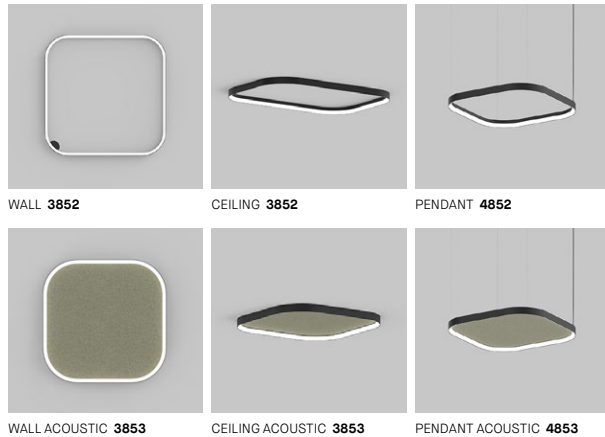

## DRIVER OPTION OPTION DE PILOTE

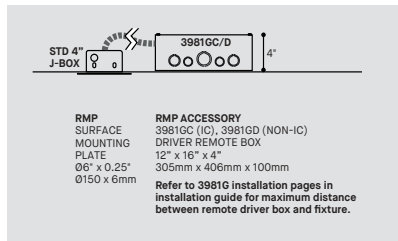

## ORDERING SPECIFICATION SPÉCIFICATION DE COMMANDE

MODEL MODÈLE		CODE
3853-44X44	ATOLL ACOUSTIC 44" X 44"	
3853-44X62	ATOLL ACOUSTIC 44" X 62"	
3853-44X82	ATOLL ACOUSTIC 44" X 82"	
3853-44X100	ATOLL ACOUSTIC 44" X 100" (SECTIONAL PANELS)	
3853-44X120	ATOLL ACOUSTIC 44" X 120" (SECTIONAL PANELS)	
3853-62X62	ATOLL ACOUSTIC 62" X 62" (SECTIONAL PANELS)	
3853-62X82	ATOLL ACOUSTIC 62" X 82" (SECTIONAL PANELS)	
3853-62X100	ATOLL ACOUSTIC 62" X 100" (SECTIONAL PANELS)	
3853-62X120	ATOLL ACOUSTIC 62" X 120" (SECTIONAL PANELS)	
3853-82X82	ATOLL ACOUSTIC 82" X 82" (SECTIONAL PANELS)	
3853-82X100	ATOLL ACOUSTIC 82" X 100" (SECTIONAL PANELS)	
3853-82X120	ATOLL ACOUSTIC 82" X 120" (SECTIONAL PANELS)	

LIGHT SOURCE SOURCE LUMINEUSE		
LED	REGULAR OUTPUT	
LED.HO	HIGH OUTPUT	

COLOR TEMPERATURE TEMPÉRATURE DE COULEUR		TW
TW*	TUNABLE WHITE (2700K TO 5000K)	
	*LONGER LEAD TIME MAY APPLY, PLEASE CONTACT YOUR EUREKA REPRESENTATIVE	

COLOR RENDERING INDEX (CRI) INDICE DE RENDU DE COULEUR (IRC)		80
80	80+ CRI	

VOLTAGE VOLTAGE		
120V	120 VOLT	
277V	277 VOLT	

CONTROL OPTION OPTION DE CONTRÔLE		
DDV	DUAL 0-10V DIMMING	
NLT*	NIGHT NTUNE CONTROL (NOT AVAILABLE FOR HO OUTPUT)	
	*LONGER LEAD TIME MAY APPLY, PLEASE CONTACT YOUR EUREKA REPRESENTATIVE	
	*REFER TO NIGHT GUIDE AND INSTALLATION SHEET FOR ALL REQUIREMENTS	

DRIVER POSITION POSITION DU PILOTE		RMP
RMP	REMOTE DRIVER (REQUIRES ACCESSORY 3981GX)	
	CONSULT CANOPY AVAILABILITY CHART AT THE END OF DOCUMENT FOR COMPATIBILITY	

CANOPY FINISH FINI PAVILLON		
BLKE	BLACK	
WHE	WHITE	
MATCH*	COLOR MATCH WITH RING FINISH	
	* LONGER LEAD TIME MAY APPLY, PLEASE CONTACT YOUR EUREKA REPRESENTATIVE	

FINISH FINI			
BLKE	BLACK	HGE*	HUNTER GREEN
WHE	WHITE	LNE*	LUNAR GREY
AYE*	APRICOT YELLOW	NBE*	NAVY BLUE
BRE*	BRICK RED	SBE*	SAND BEIGE
CBE*	CHOCOLATE BROWN	SGE*	SAGE GREY
CPE*	CLAY PINK	STE*	SUMMER TEAL
DBE*	DYNAMIC BLUE	RAL**	PLEASE SPECIFY RAL CODE
GGE*	GRASS GREEN		
	* LONGER LEAD TIME MAY APPLY, PLEASE CONTACT YOUR EUREKA REPRESENTATIVE.		
	** SPECIFY 4 DIGIT RAL CLASSIC CODE. LONGER LEAD TIME MAY APPLY, PLEASE CONTACT YOUR EUREKA REPRESENTATIVE.		

FELT FINISH FINI FEUTRE			
BBF	BASIC BLACK	MUF	MYSTIC MULBERRY
CHF	CHARCOAL	PPF	PLUM PURPLE
BTF	BATTLESHIP	BOF	BLOOD ORANGE
TGF	TITANIUM GRAY	BYF	BANANA YELLOW
SGF	SILVER GRAY	BEF	BUTTERSOTCH
PEF	PEBBLE GRAY	DYF	DAISY YELLOW
AWF	ARTIC WHITE	DTF	DEEP TEAL GREEN
OAF	OAK BROWN	GGF	GRASS GREEN
BKF	BARK BROWN	PGF	PEAR GREEN
GEF	GREIGE	SEF	SEAFOAM
LBF	LIGHT BEIGE	OGF	OLIVE GREEN
ZFF	ZINFANDEL	OBF	OCEAN BLUE
PNF	PINOT NOIR	NBF	NAVY BLUE
REF	RED	ABF	AZURE BLUE
PIF	PETAL PINK	PWF	POWDER BLUE

ACCESSORY ACCESSOIRE		
3981GC	DRIVER BOX FOR REMOTE INSTALLATION - 3.83" X 12" X 16"	
3981GD1	1 NON-IC 120V ONLY DRIVER BOX FOR REMOTE INSTALLATION - 4" X 12" X 16"	
3981GD2	1 NON-IC 277V ONLY DRIVER BOX FOR REMOTE INSTALLATION - 4" X 12" X 16"	

# ATOLL - 3853/4853 - DIMENSIONS

HEIGHT OF THE PROFILE : 3" / 74mm

WIDTH OF THE PROFILE : 1.4" / 35mm

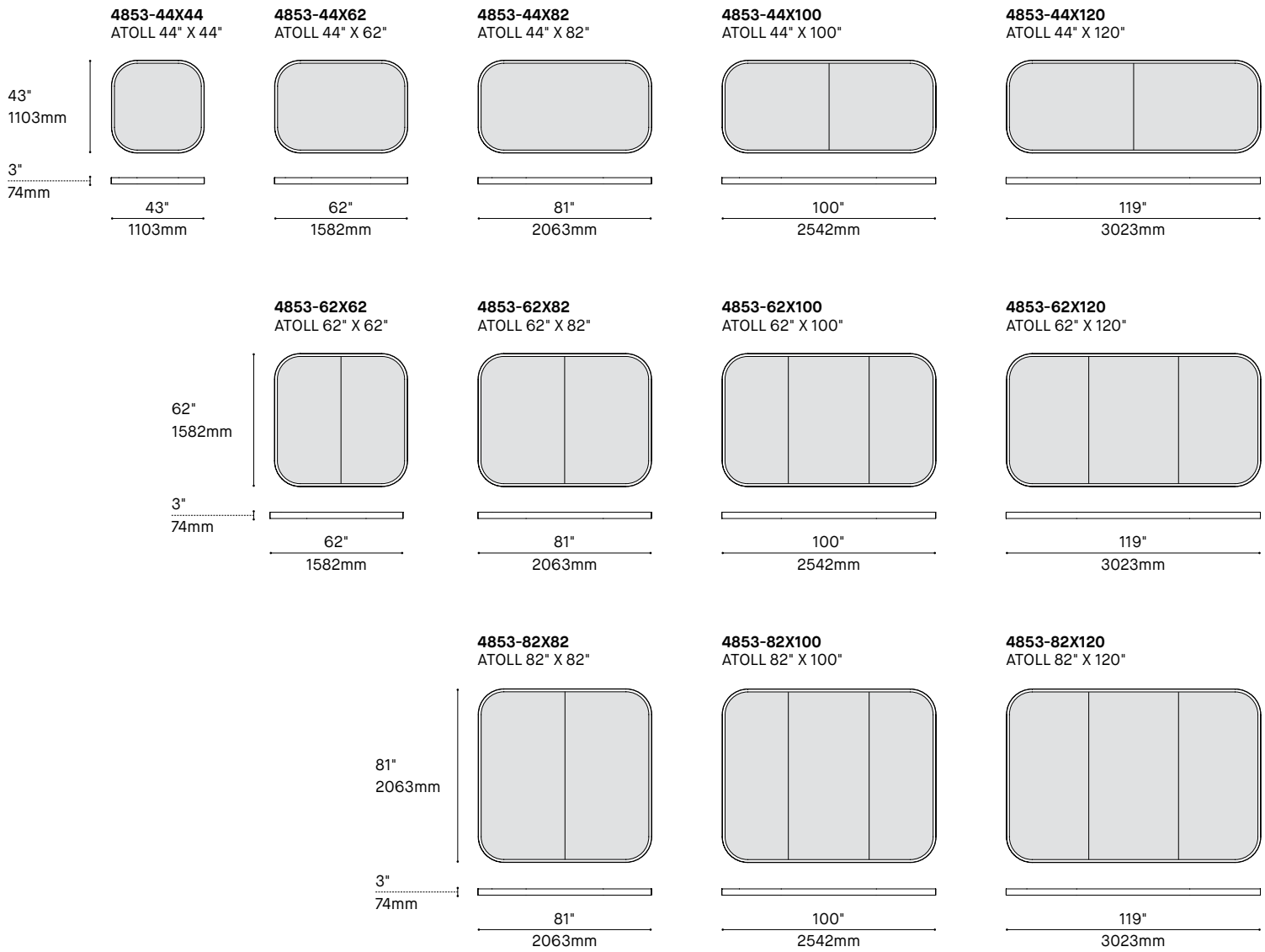

# ATOLL 3853 - WALL & CEILING ACOUSTIC

## NOISE REDUCTION

Atoll acoustic is a sound absorbing fixture designed to reduce unwanted reverberating sounds.



## ECOLOGICAL

Custom CNC cut panels composed of polyester fibers (PET) recycled content. 100% recyclable, non-toxic, non-allergenic and non-irritable. The material is also low VOC, fire rated (Class A - ASTM E84-17) and has a declare label.



## TESTED RESULTS

Tested at the renowned Riverbank Acoustic Labs for an NRC of 0.65. For more information, please refer to Acoustic documentation.

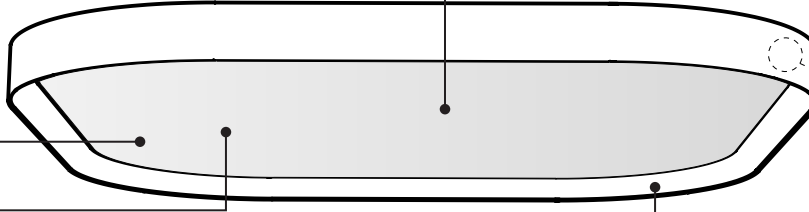

## ACOUSTIC COLORS

Available in 30 colors. For all color options\*, refer to the Acoustic Material Color Options page.

\*Certain lighter colors not available when combined with an indirect illumination.

## LARGE ACOUSTIC FAMILY

Offered in 12 different sizes up to 81"x120". An infinite number of possible layouts from the smallest to the largest space.

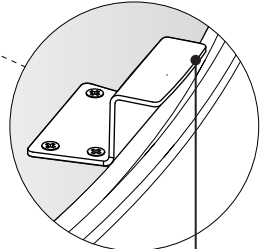

## INSTALLATION

Easy installation of the acoustic panels without tools.

## HIGH PERFORMANCE

LED illumination is controlled by 98% efficient reflectors, giving the ATOLL excellent optical and energy performance.

## SILICONE DIFFUSER

highly efficient silicone lens ensures high-performance and comfortable lighting. With anti-yellowing agents and is UV stable. Allows for a single discreet joining line across all sizes.

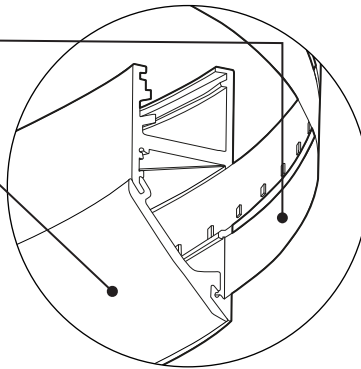

## CLEANING

A proper and regular cleaning will help extend the lifespan of acoustic products. Remove dust with a vacuum cleaner and light stains with a damp cloth. For greasy and deep stains, a professional dry clean is recommended. Do not use any abrasive, soap or chemical cleaner.

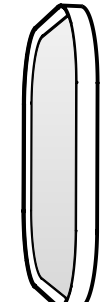

## MINIMAL SURFACE MOUNTING

With a depth of 2.9" Atoll is ADA compliant when installed on a wall.



**SMALL CANOPY**  
6" x 0.25"  
Mounts on a 4" standard j-box. Drivers in 3981G remote box for discreet installation

**3981GC/D DRIVER REMOTE BOX (RMP)** 12" x 16" x 4" (sold separately)  
Refer to install sheet for max. remote distance.

## PROFILE

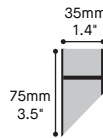

PRODUCT SPECIFICATION	44X44		44X62		44X81		44X100		44X120		62X62		62X82		62X100	
PERFORMANCE (4000K)	REG	HO	REG	HO	REG	HO	REG	HO	REG	HO	REG	HO	REG	HO	REG	HO
<b>WATTAGE - DIRECT</b>	39.0W	79.2W	48.7W	99.6W	56.7W	120W	74.9W	158.4W	74.9W	158.4W	56.7W	120W	66.9W	141.5W	74.9W	158.4W
<b>DELIVERED LUMENS</b>	3807LM	7215LM	4758LM	9065LM	5553LM	10916LM	7339LM	14429LM	7339LM	14429LM	5553LM	10916LM	6544LM	12860LM	7339LM	14429LM
<b>EFFICACY</b>	98LM/W	91LM/W	98LM/W	91LM/W	98LM/W	91LM/W	98LM/W	91LM/W	98LM/W	91LM/W	98LM/W	91LM/W	98LM/W	91LM/W	98LM/W	91LM/W
<b>OTHER INFORMATION</b>																
<b>WEIGHT OF FIXTURE</b>	16.2LBS / 7.4KG		20LBS / 9.1KG		23.8LBS / 10.8KG		27.6LBS / 12.5KG		31.4LBS / 14.3KG		23.8LBS / 10.8KG		27.6LBS / 12.5KG		31.4LBS / 14.3KG	
<b>L70 (LUMEN MAINTENANCE)</b>	> 60 000 H		> 60 000 H		> 60 000 H		> 60 000 H		> 60 000 H		> 60 000 H		> 60 000 H		> 60 000 H	

PRODUCT SPECIFICATION	62X120		82X82		81X100		82X120		100X100		100X120		120X120	
PERFORMANCE (4000K)	REG	HO	REG	HO	REG	HO	REG	HO	REG	HO	REG	HO	REG	HO
<b>WATTAGE - DIRECT</b>	85.1W	179.9W	74.9W	158.4W	80.8W	180W	88.9W	187.4W	88.9W	187.4W	93.7W	197.3W	96.4W	202.6W
<b>DELIVERED LUMENS</b>	8330LM	16374LM	7339LM	14429LM	7938LM	16374LM	8733LM	17192LM	8733LM	17192LM	9233LM	18194LM	9536LM	18816LM
<b>EFFICACY</b>	98LM/W	91LM/W	98LM/W	91LM/W	98LM/W	91LM/W	98LM/W	92LM/W	98LM/W	92LM/W	99LM/W	91LM/W	99LM/W	93LM/W
<b>OTHER INFORMATION</b>														
<b>WEIGHT OF FIXTURE</b>	35.2LBS / 16KG		31.4LBS / 14.3KG		35.2LBS / 16KG		39LBS / 17.7KG		39LBS / 17.7KG		42.8LBS / 19.5KG		46.6LBS / 21.2KG	
<b>L70 (LUMEN MAINTENANCE)</b>	> 60 000 H		> 60 000 H		> 60 000 H		> 60 000 H		> 60 000 H		> 60 000 H		> 60 000 H	

## EFFICACY MULTIPLIERS

CRIC	CT	FACTOR	TW FACTOR
80+	5000K	-	0.93
80+	4000K	-	1.00
80+	3500K	-	0.99
80+	3000K	-	0.98
80+	2700K	-	0.91
90+	4000K	1.00	-
90+	3500K	0.96	-
90+	3000K	0.92	-
90+	2700K	0.87	-

## LIGHT DISTRIBUTION

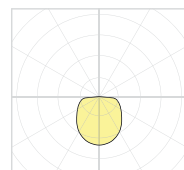

DIRECT



Visit our website for warranty terms and conditions.



## TECHNICAL DATA

# ATOLL 3853 - MURAL & PLAFOND ACOUSTIQUE

## RÉDUCTION DE BRUITS

Atoll acoustique est un luminaire conçu pour réduire les sons réverbérants non désirables.



## ECOLOGICAL

Custom CNC cut panels composed of polyester fibers (PET) recycled content. 100% recyclable, non-toxic, non-allergenic and non-irritable. The material is also low VOC, fire rated (Class A - ASTM E84-17) and has a declare label.



## MISE À L'ESSAI

Testés au renommé laboratoire acoustique Riverbank avec un coefficient de réduction du bruit (CRB/NRC) de 0.65. Pour plus d'informations, veuillez vous référer à la documentation acoustique.

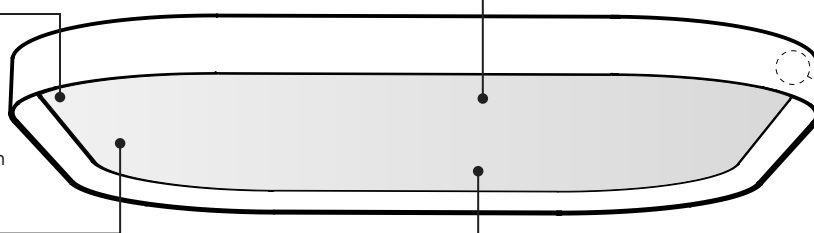

## COULEURS

Disponible en 30 couleurs standards. Pour la charte de couleurs consultez la fiche d'options\* de couleurs.

\*Certaines couleurs pâles ne sont pas compatibles avec l'illumination indirecte.

## FAMILLE ÉTENDUE

Offert en 12 tailles polyvalentes jusqu'à 81"x120". Une infinité de combinaisons possibles. Pour les petits aux plus grands espaces.

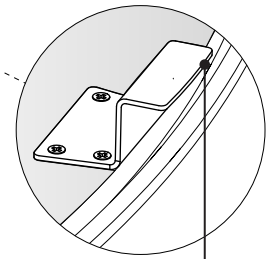

## INSTALLATION

Installation du feutre simple et sans outil.

## HAUTE PERFORMANCE

La lumière des bandes DEL est contrôlée par des réflecteurs efficaces à 98%, ce qui confère à l'ATOLL d'excellentes performances optiques et énergétiques.

## DIFFUSEUR EN SILICONE

Sa lentille en silicone très efficace assure un éclairage performant et confortable. Avec agents anti-jaunissement et une stabilité aux rayons UV. Permet d'avoir une seule ligne de joint discrète pour toutes les grandeurs.

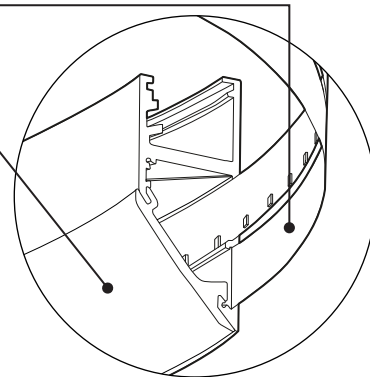

## NETTOYAGE

Un nettoyage approprié et régulier contribuera à prolonger la durée de vie des produits acoustiques. Un nettoyage périodique peut être fait avec un aspirateur ou en essuyant avec un chiffon humide. Ne pas utiliser de produits abrasifs, de savon ou de produits nettoyants chimiques.



## MONTAGE SURFACE MINIMALE

Avec une profondeur de 2.9" Atoll est conforme à la norme ADA lorsqu'installé au mur.



## PETIT PAVILLON

6" x 0.25"  
Installation minimale sur une boîte 4" standard.

Doit être combiné à la boîte à distance 3981G.

## BOÎTE PILOTES À DISTANCE (RMP) 3981G

(vendue séparément)

12" x 16" x 4" Se référer à la fiche d'installation pour la distance maximale d'éloignement.

## PROFIL

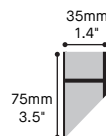

SPÉCIFICATION PRODUIT	44X44		44X62		44X81		44X100		44X120		62X62		62X82		62X100	
	REG	HO	REG	HO	REG	HO	REG	HO	REG	HO	REG	HO	REG	HO	REG	HO
PERFORMANCE (4000K)																
PUISSANCE DIRECT	39.0W	79.2W	48.7W	99.6W	56.7W	120W	74.9W	158.4W	74.9W	158.4W	56.7W	120W	66.9W	141.5W	74.9W	158.4W
UMENS RÉELS DIRECT (4000K)	3807LM	7215LM	4758LM	9065LM	5553LM	10916LM	7339LM	14429LM	7339LM	14429LM	5553LM	10916LM	6544LM	12860LM	7339LM	14429LM
EFFICACITÉ DIRECT	98LM/W	91LM/W	98LM/W	91LM/W	98LM/W	91LM/W	98LM/W	91LM/W	98LM/W	91LM/W	98LM/W	91LM/W	98LM/W	91LM/W	98LM/W	91LM/W
OTHER AUTRES INFORMATIONS																
POIDS DU LUMINAIRE	16.2LBS / 7.4KG		20LBS / 9.1KG		23.8LBS / 10.8KG		27.6LBS / 12.5KG		31.4LBS / 14.3KG		23.8LBS / 10.8KG		27.6LBS / 12.5KG		31.4LBS / 14.3KG	
L70 (MAINTENANCE DE LA LUMIÈRE)	> 60 000 H		> 60 000 H		> 60 000 H		> 60 000 H		> 60 000 H		> 60 000 H		> 60 000 H		> 60 000 H	

SPÉCIFICATION PRODUIT	62X120		82X82		81X100		82X120		100X100		100X120		120X120	
	REG	HO	REG	HO	REG	HO	REG	HO	REG	HO	REG	HO	REG	HO
PERFORMANCE (4000K)														
PUISSANCE DIRECT	85.1W	179.9W	74.9W	158.4W	80.8W	180W	88.9W	187.4W	88.9W	187.4W	93.7W	197.3W	96.4W	202.6W
UMENS RÉELS DIRECT (4000K)	8330LM	16374LM	7339LM	14429LM	7938LM	16374LM	8733LM	17192LM	8733LM	17192LM	9233LM	18194LM	9536LM	18816LM
EFFICACITÉ DIRECT	98LM/W	91LM/W	98LM/W	91LM/W	98LM/W	91LM/W	98LM/W	92LM/W	98LM/W	92LM/W	99LM/W	91LM/W	99LM/W	93LM/W
OTHER AUTRES INFORMATIONS														
POIDS DU LUMINAIRE	35.2LBS / 16KG		31.4LBS / 14.3KG		35.2LBS / 16KG		39LBS / 17.7KG		39LBS / 17.7KG		42.8LBS / 19.5KG		46.6LBS / 21.2KG	
L70 (MAINTENANCE DE LA LUMIÈRE)	> 60 000 H		> 60 000 H		> 60 000 H		> 60 000 H		> 60 000 H		> 60 000 H		> 60 000 H	

## FACTEUR D'EFFICACITÉ

CRIC	CT	FACTOR	TW FACTOR
80+	5000K	-	0.93
80+	4000K	-	1.00
80+	3500K	-	0.99
80+	3000K	-	0.98
80+	2700K	-	0.91
90+	4000K	1.00	-
90+	3500K	0.96	-
90+	3000K	0.92	-
90+	2700K	0.87	-

## DISTRIBUTION LUMINEUSE

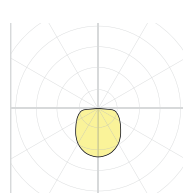

DIRECTE



Visitez notre site Web pour les termes et conditions.



## DONNÉES TECHNIQUES

# Acoustic Material Color Options



**BBF**  
Basic Black



**CHF**  
Charcoal



**BTF**  
Battleship



**TGF**  
Titanium Gray



**SGF**  
Silver Gray



**PEF**  
Pebble Gray



**AWF**  
Artic White

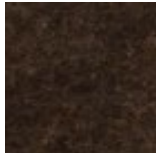

**OAF**  
Oak Brown



**BKF**  
Bark Brown



**GEF**  
Greige



**LBF**  
Light Beige



**ZFF**  
Zinfandel

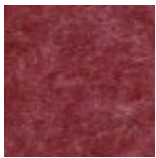

**PNF**  
Pinot Noir



**REF**  
Red

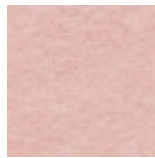

**PIF**  
Petal Pink



**MUF**  
Mystic Mulberry

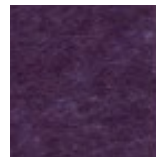

**PPF**  
Plum Purple



**BOF**  
Blood Orange



**BYF**  
Banana Yellow



**BEF**  
Butterscotch

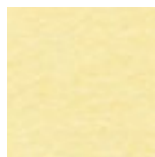

**DYF**  
Daisy Yellow

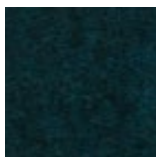

**DTF**  
Deep Teal Green

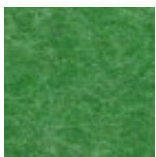

**GGF**  
Grass Green

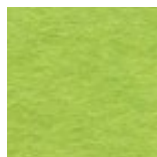

**PGF**  
Pear Green



**SEF**  
Seafoam

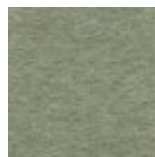

**OGF**  
Olive Green

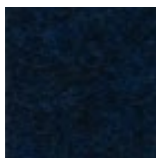

**OBF**  
Ocean Blue



**NBF**  
Navy Blue



**ABF**  
Azure Blue





**PWF**  
Powder Blue

# ATOLL - 4852 DIRECT, 3852/3853 SURFACE : CANOPY COMPATIBILITY CHART

DD : DUAL 0-10V DIMMING CONTROL FOR TUNABLE WHITE  
 NT : NTUNE WIRELESS CONTROL FOR TUNABLE WHITE  
 DP : PHASE DIMMING

BLANK SPACE = NOT AVAILABLE  
 HO-REG OR REG-HO ARE EQUIVALENT IN THE CHART BELOW  
 IC / NON-IC : NON-IC REMOTE BOXES CANNOT BE IN CONTACT WITHIN 3" OF INSULATION

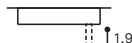
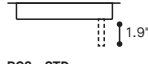
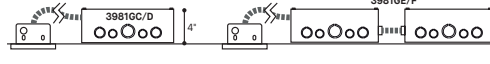
 FIXTURE	PHASE DIMMING OPTION	CANOPY								
		RC1	RC2	RC3			RC5 (RMP)			
		 RC1 Ø5.50" x 1.35" Ø140 x 34.3mm*	 RC2 - WIRED / AIR Ø7.75" x 1.30" Ø196.9 x 33mm*	 RC3 - STD RC3 - WIRED / AIR Ø9.4" x 1.88" Ø238.8 x 47.8mm*			 RC5 (RMP) 247IC 04.5" x 0.5" Ø114 x 13mm		RC5 (RMP) ACCESSORY 3981GC (IC), 3981GD (NON-IC) DRIVER REMOTE BOX 12" x 16" x 4" 305mm x 406mm x 100mm	
DIMENSIONS D = DIRECT, I = INDIRECT ILLUMINANCE : REG OR HO		COMPATIBILITY			FOR REMOTE LOCATION OR CAN BE REQUIRED TO FIT HIGHER POWER OR NLIGHT IF NOT AVAILABLE IN RC1,2,3,4		NLIGHT WIRED	TUNABLE WHITE		
44X44 D - REG	DP	✓	✓		DD+NT		3981GC	✓	DD/NT	
44X44 D - HO				✓	DD		3981GC	✓	DD	
44X62 D - REG	DP	✓	✓		DD+NT		3981GC	✓	DD/NT	
44X62 D - HO				✓	DD		3981GC	✓	DD	
44X81 D - REG	DP			✓	DD+NT	✓	3981GC	✓	DD/NT	
44X81 D - HO	DP			✓	DD	✓	3981GC	✓	DD	
44X100 D - REG				✓	DD+NT		3981GC	✓	DD/NT	
44X100 D - HO				✓	DD		3981GC	✓	DD	
44X120 D - REG				✓	DD+NT		3981GC	✓	DD/NT	
44X120 D - HO				✓	DD		3981GC	✓	DD	
62X62 D - REG	DP			✓	DD+NT	✓	3981GC	✓	DD/NT	
62X62 D - HO	DP			✓	DD	✓	3981GC	✓	DD	
62X81 D - REG				✓	DD+NT		3981GC	✓	DD/NT	
62X81 D - HO				✓	DD		3981GC	✓	DD	
62X100 D - REG				✓	DD+NT		3981GC	✓	DD/NT	
62X100 D - HO				✓	DD		3981GC	✓	DD	
62X120 D - REG				✓	DD		3981GC	✓	DD	
62X120 D - HO				✓			NON-IC : 3981GD1 (120V) / 3981GD2 (277V)	✓		
81X81 D - REG				✓	DD+NT		3981GC	✓	DD/NT	
81X81 D - HO				✓	DDV		3981GC	✓	DD	
81X100 D - REG				✓	DD		3981GC	✓	DD	
81X100 D - HO				✓			NON-IC : 3981GD1 (120V) / 3981GD2 (277V)	✓		
81X120 D - REG				✓	DD		3981GC	✓	DD	
81X120 D - HO				✓			NON-IC : 3981GD1 (120V) / 3981GD2 (277V)	✓		
100X100 D - REG				✓	DD		3981GC	✓	DD	
100X100 D - HO				✓			NON-IC : 3981GD1 (120V) / 3981GD2 (277V)	✓		
100X120 D - REG				✓	DD		3981GC	✓	DD	
100X120 D - HO				✓			NON-IC : 3981GD1 (120V) / 3981GD2 (277V)	✓		
120X120 D - REG				✓	DD		3981GC	✓	DD	
120X120 D - HO				✓			NON-IC : 3981GD1 (120V) / 3981GD2 (277V)	✓		



SPECIFICATION