

ATOLL - 4852

PROJECT PROJÉT
SPEC TYPE
NOTES

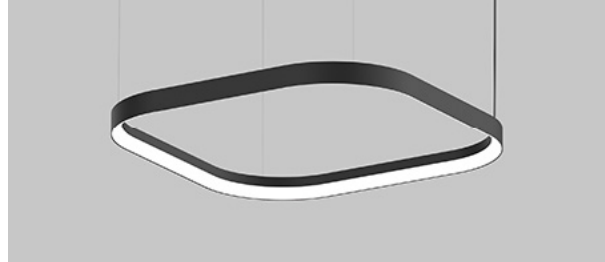

FINISH FINI



INDIRECT OPTIONS OPTIONS INDIRECT

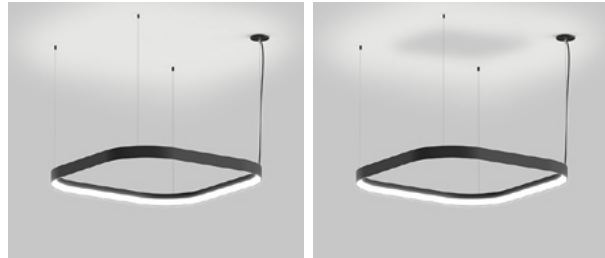

4852DI-B

4852DI-L

FAMILY FAMILLE

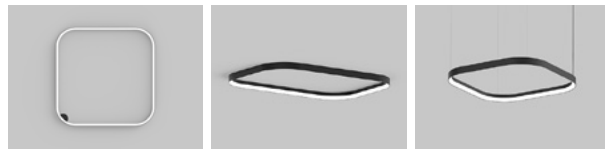

WALL 3852

CEILING 3852

PENDANT 4852

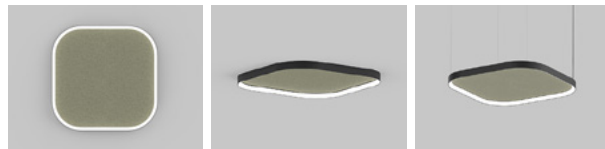

WALL ACOUSTIC 3853

CEILING ACOUSTIC 3853

PENDANT ACOUSTIC 4853

ORDERING SPECIFICATION SPÉCIFICATION DE COMMANDE

CODE

MODEL MODÈLE

4852D ATOLL PENDANT - DIRECT ILLUMINATION
4852DI-B* ATOLL PENDANT - DIRECT LAMBERTIAN & INDIRECT BATHING ILLUMINATION (DUAL DIMMING)
4852DI-L* ATOLL PENDANT - DIRECT LAMBERTIAN & INDIRECT LAMBERTIAN ILLUMINATION (DUAL DIMMING)
*DOWNLIGHT AND UPLIGHT ARE DIMMED INDEPENDENTLY - EXCEPT WITH NLIGHT CONTROLS

SIZE TAILLE

4852-44X44 ATOLL PENDANT 44" X 44"
4852-44X62 ATOLL PENDANT 44" X 62"
4852-44X82 ATOLL PENDANT 44" X 82"
4852-44X100 ATOLL PENDANT 44" X 100"
4852-44X120 ATOLL PENDANT 44" X 120"
4852-62X62 ATOLL PENDANT 62" X 62"
4852-62X82 ATOLL PENDANT 62" X 82"
4852-62X100 ATOLL PENDANT 62" X 100"
4852-62X120 ATOLL PENDANT 62" X 120"
4852-82X82 ATOLL PENDANT 82" X 82"
4852-82X100 ATOLL PENDANT 82" X 100"
4852-82X120 ATOLL PENDANT 82" X 120"
4852-100X100 ATOLL PENDANT 100" X 100"
4852-100X120 ATOLL PENDANT 100" X 120"
4852-120X120 ATOLL PENDANT 120" X 120"

DIRECT LIGHT SOURCE SOURCE LUMINEUSE DIRECTE

LED REGULAR OUTPUT
LED.HO HIGH OUTPUT

INDIRECT LIGHT SOURCE SOURCE LUMINEUSE INDIRECTE

LED REGULAR OUTPUT
LED.HO HIGH OUTPUT

COLOR TEMPERATURE TEMPÉRATURE DE COULEUR

27 2700K
30 3000K
35 3500K
40* 4000K
* LONGER LEAD TIME MAY APPLY, PLEASE CONTACT YOUR EUREKA REPRESENTATIVE

COLOR RENDERING INDEX (CRI) INDICE DE RENDU DE COULEUR (IRC)

90 90+ CRI **90**

VOLTAGE VOLTAGE

120V 120 VOLT
277V 277 VOLT

CONTROL OPTION OPTION DE CONTRÔLE

DV 0-10V DIMMING (120V-277V)
DP* PHASE DIMMING (120V ONLY)
NLTAIR2** NLIGHT AIR CONTROL GEN 2
NLIGHT** NLIGHT WIRED CONTROL
* ONLY AVAILABLE REGULAR OUTPUT
 ** CONSULT CANOPY AVAILABILITY CHART AT THE END OF DOCUMENT FOR COMPATIBILITY
 *** NLIGHT INTEGRATION REQUIRES THE USAGE OF A REMOTE POWER PACK
 **** LONGER LEAD TIME MAY APPLY, PLEASE CONTACT YOUR EUREKA REPRESENTATIVE
 REFER TO NLIGHT GUIDE AND INSTALLATION SHEET FOR ALL REQUIREMENTS

EMERGENCY BATTERY BATTERIE D'URGENCE

EM DRIVER BOX INCLUDED, INSTALLED REMOTELY. SEE EM GUIDE 3981E FOR DETAILS
EMB* EMERGENCY BATTERY FOR REMOTE BOX
* 3981EA ACCESSORY IS REQUIRED FOR THIS OPTION

DRIVER POSITION POSITION DU PILOTE

CONSULT CANOPY AVAILABILITY CHART AT THE END OF DOCUMENT FOR COMPATIBILITY
RMP REMOTE DRIVER (REQUIRES ACCESSORY 3981GX)

CABLE CÂBLE

AC AIRCRAFT MOUNTING AND BLACK OR WHITE CABLE, FIELD ADJUSTABLE **AC**

CABLE LENGTH LONGUEUR DE CÂBLE

60 60" CABLE (STD LENGTH)
****** CUSTOM CABLE LENGTH (PLEASE SPECIFY)
FOR OVERALL LENGTH, PLEASE CONTACT YOUR EUREKA REPRESENTATIVE

MOUNTING OPTION OPTION DE MONTAGE

CENTERED RECTANGULAR CANOPY / PAVILLON RECTANGULAIRE CENTRÉ
RC1 SCREWLESS CANOPY Ø5.5" X 1.4" (2473F)
RC2 NLIGHT SCREWLESS CANOPY Ø7.8" X 1.3" (2474H)
RC3 STANDARD & NLIGHT SCREWLESS CANOPY Ø9.4" X 1.9" (2475I)
RC5* REMOTE DRIVER OPTION SCREWLESS CANOPY Ø4.5" X 0.5" (2471C)
* REQUIRES ACCESSORY 3981GX

ATOLL - 4852

MOUNTING OPTION OPTION DE MONTAGE

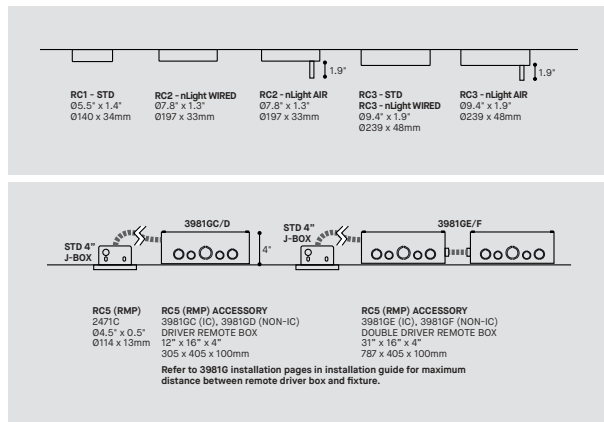

MOUNTING CABLE OPTION OPTION DE MONTAGE DE CÂBLE

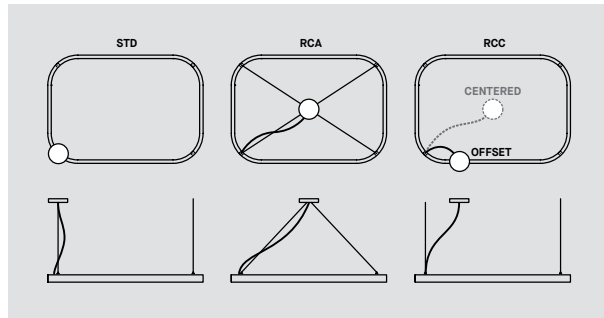

ORDERING SPECIFICATION SPÉCIFICATION DE COMMANDE

CODE

MOUNTING CABLE OPTION OPTION DE MONTAGE DE CÂBLE

RCA CENTERED ROUND CANOPY - AIRCRAFT CABLES ANGLED TO CENTER
RCC USER LOCATED ROUND CANOPY - STRAIGHT AIRCRAFT CABLES
NO SELECTION = STD OFF-CENTERED ROUND CANOPY WITH STRAIGHT AIRCRAFT CABLES

CANOPY FINISH FINI PAVILLON

BLKE BLACK
WHE WHITE
MATCH* COLOR MATCH WITH RING FINISH
* LONGER LEAD TIME MAY APPLY, PLEASE CONTACT YOUR EUREKA REPRESENTATIVE

POWER CORD FINISH FINI CÂBLE D'ALIMENTATION

BLK BLACK POWER CORD
WH WHITE POWER CORD

FINISH FINI

BLKE BLACK	HGE* HUNTER GREEN
WHE WHITE	LNE* LUNAR GREY
AYE* APRICOT YELLOW	NBE* NAVY BLUE
BRE* BRICK RED	SBE* SAND BEIGE
CBE* CHOCOLATE BROWN	SGE* SAGE GREY
CPE* CLAY PINK	STE* SUMMER TEAL
DBE* DYNAMIC BLUE	RAL** PLEASE SPECIFY RAL CODE
GGE* GRASS GREEN	

* LONGER LEAD TIME MAY APPLY, PLEASE CONTACT YOUR EUREKA REPRESENTATIVE.
** SPECIFY 4 DIGIT RAL CLASSIC CODE. LONGER LEAD TIME MAY APPLY, PLEASE CONTACT YOUR EUREKA REPRESENTATIVE.

ACCESSORY ACCESSOIRE

CONSULT CANOPY AVAILABILITY CHART AT THE END OF DOCUMENT FOR COMPATIBILITY

3981GC 1 DRIVER BOX FOR REMOTE INSTALLATION - 4" X 12" X 16"
3981GD1 1 NON-IC 120V ONLY DRIVER BOX FOR REMOTE INSTALLATION - 4" X 12" X 16"
3981GD2 1 NON-IC 277V ONLY DRIVER BOX FOR REMOTE INSTALLATION - 4" X 12" X 16"
3981GE 2 DRIVER BOXES FOR REMOTE INSTALLATION - 4" X 31" X 16"
3981GF1 2 NON-IC 120V ONLY DRIVER BOXES FOR REMOTE INSTALLATION - 4" X 31" X 16"
3981GF2 2 NON-IC 277V ONLY DRIVER BOXES FOR REMOTE INSTALLATION - 4" X 31" X 16"
39NLAA NLIGHT AIR GEN 2 REMOTE CONTROLLER
39NLWA NLIGHT WIRED REMOTE CONTROLLER

ACCESSORY EMERGENCY BATTERY ACCESSOIRE BATTERIE D'URGENCE

3981EA ELECTRICAL BOX FOR 10W EMB EMERGENCY BATTERY - 4" X 12" X 16"

PRODUCT CHARACTERISTICS CARACTÉRISTIQUES DU PRODUIT



DESIGN: Atoll is a high-performance fixture producing an evenly distributed luminous glow. Adaptable to many spaces with its round and rectangular shapes, a range of sizes and mounting options. The slim profile with its angled knife-edge diffuser expresses a contemporary refinement, allowing it to effortlessly integrate interiors with simplicity and elegance.

INSTALLATION: Whether wall or ceiling mounted, Atoll has a simple 3 or 4 point mounting system. Custom designed and manufactured light engine featuring high performance discreet LEDs. Tunable white, wireless control and emergency option available.

LIGHT SOURCE:

CONSTRUCTION: Seamlessly finished, rolled aluminium extrusion profile paired with high efficiency reflectors and a flexible silicone diffuser. Architectural grade matte polyester powder coating outer finish available in a range of colours.

CONCEPTION: Atoll est un luminaire de haute performance qui produit une illumination uniforme. Il s'adapte aisément avec ses deux formes, une gamme de tailles et une variété d'options de montage. Il est doté d'un diffuseur biseauté compacte qui exprime une forme contemporaine et lui permet de remplir les espaces avec simplicité et élégance.

INSTALLATION: Que ce soit en suspension ou en surface, Atoll dispose d'un système de montage simple à 3 ou 4 points.

SOURCE LUMINEUSE: Module conçu et fabriqué sur mesure avec des DEL discretes de haute performance. Blanc dynamique, contrôle à sans-fil ou batterie d'urgence disponible.

BASE: Profilé en aluminium extrudé et roulé sans ligne de joint visible, accompagné de réflecteurs à haute efficacité et d'un diffuseur flexible en silicone. Finition extérieure par revêtement de polyester mat de grade architectural disponible en blanc et noir.

ATOLL - 4852 - TUNABLE WHITE

PROJECT PROJÉT
SPEC TYPE
NOTES

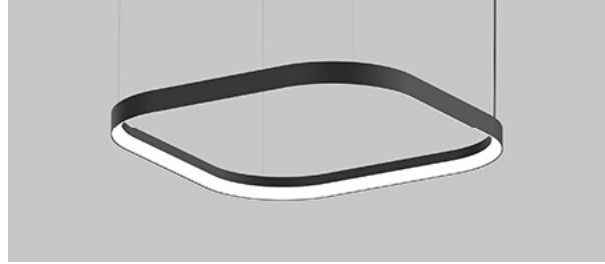

FINISH FINI



INDIRECT OPTIONS OPTIONS INDIRECT

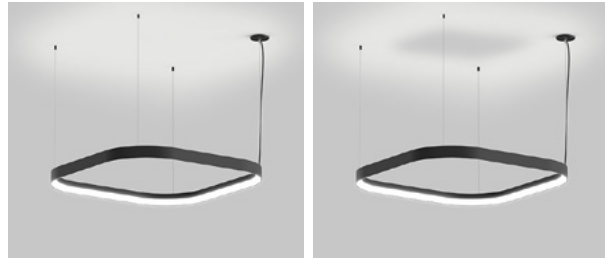

4852DI-B

4852DI-L

FAMILY FAMILLE



WALL 3852

CEILING 3852

PENDANT 4852

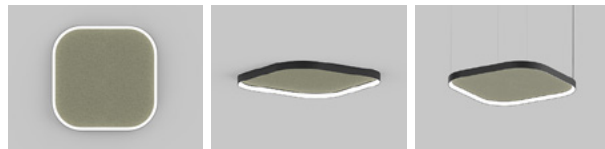

WALL ACOUSTIC 3853

CEILING ACOUSTIC 3853

PENDANT ACOUSTIC 4853

ORDERING SPECIFICATION	SPÉCIFICATION DE COMMANDE	CODE
MODEL MODÈLE		
4852D	ATOLL PENDANT - DIRECT ILLUMINATION	
4852DI-B*	ATOLL PENDANT - DIRECT LAMBERTIAN & INDIRECT BATWING ILLUMINATION (DUAL DIMMING)	
4852DI-L*	ATOLL PENDANT - DIRECT LAMBERTIAN & INDIRECT LAMBERTIAN ILLUMINATION (DUAL DIMMING) *DOWNLIGHT AND UPLIGHT ARE DIMMED INDEPENDENTLY - EXCEPT WITH NLIGHT CONTROLS	
SIZE TAILLE		
44X44	ATOLL PENDANT 44" X 44"	
44X62	ATOLL PENDANT 44" X 62"	
44X82	ATOLL PENDANT 44" X 82"	
44X100	ATOLL PENDANT 44" X 100"	
44X120	ATOLL PENDANT 44" X 120"	
62X62	ATOLL PENDANT 62" X 62"	
62X82	ATOLL PENDANT 62" X 82"	
62X100	ATOLL PENDANT 62" X 100"	
62X120	ATOLL PENDANT 62" X 120"	
82X82	ATOLL PENDANT 82" X 82"	
82X100	ATOLL PENDANT 82" X 100"	
82X120	ATOLL PENDANT 82" X 120"	
100X100	ATOLL PENDANT 100" X 100"	
100X120	ATOLL PENDANT 100" X 120"	
120X120	ATOLL PENDANT 120" X 120"	
DIRECT LIGHT SOURCE SOURCE LUMINEUSE DIRECTE		
LED	REGULAR OUTPUT	
LED.HO*	HIGH OUTPUT *CONSULT CANOPY AVAILABILITY CHART AT THE END OF DOCUMENT FOR COMPATIBILITY	
INDIRECT LIGHT SOURCE SOURCE LUMINEUSE INDIRECTE		
LED	REGULAR OUTPUT	
LED.HO*	HIGH OUTPUT *CONSULT CANOPY AVAILABILITY CHART AT THE END OF DOCUMENT FOR COMPATIBILITY	
COLOR TEMPERATURE TEMPÉRATURE DE COULEUR		
TW*	TUNABLE WHITE (2700K TO 5000K) * LONGER LEAD TIME MAY APPLY, PLEASE CONTACT YOUR EUREKA REPRESENTATIVE	
COLOR RENDERING INDEX (CRI) INDICE DE RENDU DE COULEUR (IRC)		80
80	80+ CRI	
VOLTAGE VOLTAGE		
120V	120 VOLT	
277V	277 VOLT	
CONTROL OPTION OPTION DE CONTRÔLE		
DDV	DUAL 0-10V DIMMING	
NLT*	NLIGHT NTUNE CONTROL *CONSULT CANOPY AVAILABILITY CHART AT THE END OF DOCUMENT FOR COMPATIBILITY *LONGER LEAD TIME MAY APPLY, PLEASE CONTACT YOUR EUREKA REPRESENTATIVE REFER TO NLIGHT GUIDE AND INSTALLATION SHEET FOR ALL REQUIREMENTS	
DRIVER POSITION POSITION DU PILOTE		
CONSULT CANOPY AVAILABILITY CHART AT THE END OF DOCUMENT FOR COMPATIBILITY		
RMP	REMOTE DRIVER (REQUIRES ACCESSORY 3981GX)	
CABLE CÂBLE		AC
AC	AIRCRAFT MOUNTING AND BLACK OR WHITE CABLE, FIELD ADJUSTABLE	
CABLE LENGTH LONGUEUR DE CÂBLE		
60	60" CABLE (STD LENGTH)	
**	CUSTOM CABLE LENGTH (PLEASE SPECIFY) FOR OVERALL LENGTH, PLEASE CONTACT YOUR EUREKA REPRESENTATIVE	
MOUNTING OPTION OPTION DE MONTAGE		
CONSULT CANOPY AVAILABILITY CHART AT THE END OF DOCUMENT FOR COMPATIBILITY		
RC3	STANDARD SCREWLESS CANOPY Ø9.4" X 1.9" (2475I)	
RC5*	REMOTE DRIVER OPTION SCREWLESS CANOPY Ø4.5" X 0.5" (2471C) *REQUIRES ACCESSORY 3981GC, WITH NLIGHT, 39NLWA WIRED REMOTE CONTROLLER IS INCLUDED	
MOUNTING CABLE OPTION OPTION DE MONTAGE DE CÂBLE		
RCA	CENTERED ROUND CANOPY - AIRCRAFT CABLES ANGLED TO CENTER	
RCC	USER LOCATED ROUND CANOPY - STRAIGHT AIRCRAFT CABLES NO SELECTION - STD OFF-CENTERED ROUND CANOPY WITH STRAIGHT AIRCRAFT CABLES	
CANOPY FINISH FINI PAVILLON		
BLKE	BLACK	
WHE	WHITE	
MATCH*	COLOR MATCH WITH RING FINISH * LONGER LEAD TIME MAY APPLY, PLEASE CONTACT YOUR EUREKA REPRESENTATIVE	
POWER CORD FINISH FINI CÂBLE D'ALIMENTATION		
BLK	BLACK POWER CORD	
WH	WHITE POWER CORD	

ATOLL - 4852 - TUNABLE WHITE

MOUNTING OPTION OPTION DE MONTAGE

RC1 - STD
 05.5" x 1.4"
 0140 x 34mm

RC2 - nLight WIRED
 07.8" x 1.3"
 0197 x 33mm

RC2 - nLight AIR
 07.8" x 1.3"
 0197 x 33mm

RC3 - STD
RC3 - nLight WIRED
 09.4" x 1.9"
 0239 x 48mm

RC3 - nLight AIR
 09.4" x 1.9"
 0239 x 48mm

RCS (RMP)
 247C
 04.5" x 0.5"
 0114 x 13mm

RCS (RMP) ACCESSORY
 3981GC (I), 3981GD (NON-IC)
 DRIVER REMOTE BOX
 12" x 16" x 4"
 305 x 405 x 100mm

RCS (RMP) ACCESSORY
 3981GE (IC), 3981GF (NON-IC)
 DOUBLE DRIVER REMOTE BOX
 31" x 16" x 4"
 787 x 405 x 100mm

Refer to 3981G installation pages in installation guide for maximum distance between remote driver box and fixture.

MOUNTING CABLE OPTION OPTION DE MONTAGE DE CÂBLE

STD

RCA

RCC
 CENTERED
 OFFSET

ORDERING SPECIFICATION SPÉCIFICATION DE COMMANDE

CODE

FINISH FINI

BLKE	BLACK	HGE*	HUNTER GREEN
WHE	WHITE	LNE*	LUNAR GREY
AYE*	APRICOT YELLOW	NBE*	NAVY BLUE
BRE*	BRICK RED	SBE*	SAND BEIGE
CBE*	CHOCOLATE BROWN	SGE*	SAGE GREY
CPE*	CLAY PINK	STE*	SUMMER TEAL
DBE*	DYNAMIC BLUE	RAL**	PLEASE SPECIFY RAL CODE
GGE*	GRASS GREEN		

* LONGER LEAD TIME MAY APPLY. PLEASE CONTACT YOUR EUREKA REPRESENTATIVE.
 ** SPECIFY 4 DIGIT RAL CLASSIC CODE. LONGER LEAD TIME MAY APPLY. PLEASE CONTACT YOUR EUREKA REPRESENTATIVE.

ACCESSORY ACCESSOIRE

CONSULT CANOPY AVAILABILITY CHART AT THE END OF DOCUMENT FOR COMPATIBILITY

3981GC	1 DRIVER BOX FOR REMOTE INSTALLATION - 4" X 12" X 16"
3981GD1	1 NON-IC 120V ONLY DRIVER BOX FOR REMOTE INSTALLATION - 4" X 12" X 16"
3981GD2	1 NON-IC 277V ONLY DRIVER BOX FOR REMOTE INSTALLATION - 4" X 12" X 16"

PRODUCT CHARACTERISTICS CARACTÉRISTIQUES DU PRODUIT



ATOLL SQUARE & RECTANGLE - 4852 - DIMENSIONS

HEIGHT OF THE PROFILE : 3" / 74mm

WIDTH OF THE PROFILE : 1.4" / 35mm

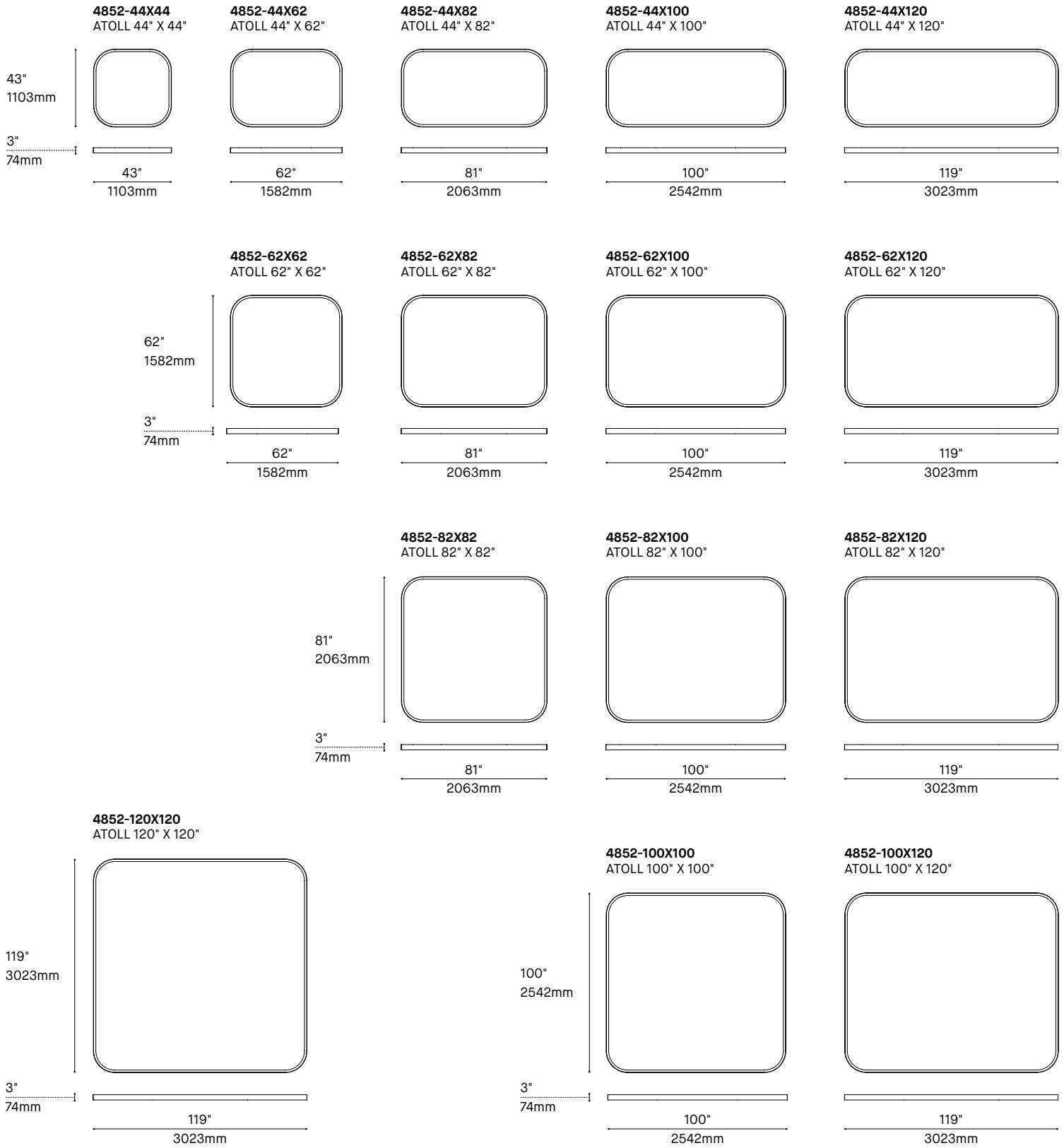

ATOLL 4852

LARGE FAMILY

Offered in 15 different sizes.
An infinite number of possible layouts.
From the smallest to the largest space.

HIGH PERFORMANCE

LED illumination is controlled by 98% efficient reflectors, giving the ATOLL excellent optical and energy performance.
Combined with its highly efficient silicone lens ensures high-performance and comfortable lighting.

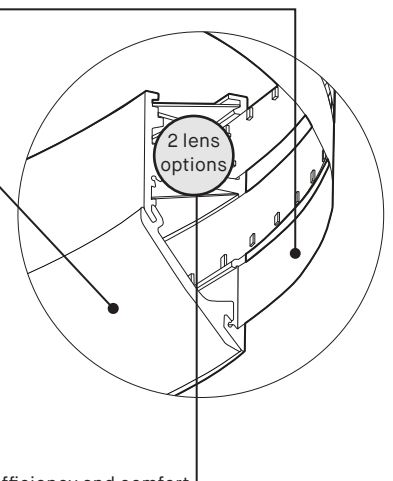
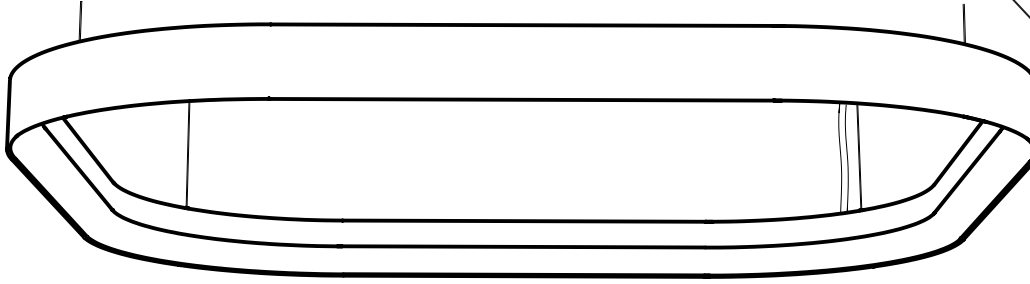

ARCHITECTURAL LIGHTING VERSATILITY

ATOLL offers two versatile architectural indirect lighting options, to illuminate all kinds of spaces with optimal efficiency and comfort

4850DI-B

BATWING OPTION

The indirect lighting offers a batwing light distribution with the help of aluminum reflectors, protected by a clear dust cover. This allows for an even uplight illumination, ideal for the low ceiling application. This option is when the indirect light source will be out of sight.

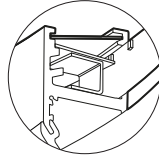

4850DI-L

LAMBERTIAN OPTION

A silicone lens helps diffuse indirect light by scattering it evenly across its textured surface, reducing glare and ensuring a uniform illumination. Suited for 36in mounting distance and above. This option is optimal when the indirect light source may be visible from certain angles.

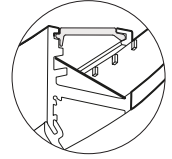

RECOMMENDED MINIMUM DISTANCE FROM CEILING (from the top of the fixture)

LONGEST SIDE LENGTH	44	62	82	100	120
DISTANCE	10"	12"	12"	15"	18"

RECOMMENDED MINIMUM DISTANCE FROM CEILING (from the top of the fixture)

SIZE : ALL
DISTANCE : 24" min. recommended.

PRODUCT SPECIFICATION	44X44		44X62		44X81		44X100		44X120		62X62		62X82		62X100	
PERFORMANCE (4000K)	REG	HO	REG	HO	REG	HO	REG	HO	REG	HO	REG	HO	REG	HO	REG	HO
WATTAGE - DIRECT	39.0W	79.2W	48.7W	99.6W	56.7W	120W	74.9W	158.4W	74.9W	158.4W	56.7W	120W	66.9W	141.5W	74.9W	158.4W
WATTAGE - INDIRECT	19.3W	39.6W	28.4W	60W	39.0W	79.2W	56.7W	120W	56.7W	120W	39W	79.2W	48.7W	99.6W	56.7W	120.0W
DELIVERED LUMENS - DIRECT	3807LM	7215LM	4758LM	9065LM	5553LM	10916LM	7339LM	14429LM	7339LM	14429LM	5553LM	10916LM	6544LM	12860LM	7339LM	14429LM
DELIVERED LUMENS - INDIRECT BATWING	2729LM	5223LM	4023LM	7907LM	5515LM	5553LM	8045LM	15814LM	8045LM	15814LM	5515LM	10452LM	6893LM	13133LM	8045LM	15814LM
DELIVERED LUMENS - INDIRECT LAMBERT	2192LM	4197LM	3230LM	6350LM	4429LM	8394LM	5536LM	10547LM	6461LM	12700LM	4429LM	8394LM	5536LM	10547LM	6461LM	12700LM
EFFICACY DIRECT	98LM/W	91LM/W	98LM/W	91LM/W	91LM/W	98LM/W	98LM/W	91LM/W	98LM/W	98LM/W	91LM/W	98LM/W	98LM/W	91LM/W	98LM/W	91LM/W
EFFICACY INDIRECT BATWING	142LM/W	132LM/W	142LM/W	132LM/W	141LM/W	132LM/W	141LM/W	132LM/W	141LM/W	132LM/W	141LM/W	132LM/W	141LM/W	132LM/W	142LM/W	132LM/W
EFFICACY INDIRECT LAMBERTIAN	114LM/W	106LM/W	114LM/W	106LM/W	114LM/W	106LM/W	114LM/W	106LM/W	114LM/W	106LM/W	114LM/W	106LM/W	114LM/W	106LM/W	114LM/W	106LM/W
OTHER INFORMATION																
WEIGHT OF FIXTURE	16.2LBS / 7.4KG		20LBS / 9.1KG		23.8LBS / 10.8KG		27.6LBS / 12.5KG		31.4LBS / 14.3KG		23.8LBS / 10.8KG		27.6LBS / 12.5KG		31.4LBS / 14.3KG	
L70 (LUMEN MAINTENANCE)	> 60 000 H		> 60 000 H		> 60 000 H		> 60 000 H		> 60 000 H		> 60 000 H		> 60 000 H		> 60 000 H	

PRODUCT SPECIFICATION	62X120		82X82		81X100		82X120		100X100		100X120		120X120	
PERFORMANCE (4000K)	REG	HO	REG	HO	REG	HO	REG	HO	REG	HO	REG	HO	REG	HO
WATTAGE - DIRECT	85.1W	179.9W	74.9W	158.4W	80.8W	180W	88.9W	187.4W	88.9W	187.4W	85.1W	179.9W	96.4W	202.6W
WATTAGE - INDIRECT	66.9W	141.5W	56.7W	120W	66.9W	141.5W	74.9W	172.6W	74.9W	172.6W	66.9W	141.5W	96.4W	202.6W
DELIVERED LUMENS - DIRECT	8330LM	16374LM	7339LM	14429LM	7938LM	16374LM	8733LM	17192LM	8733LM	17192LM	8330LM	16374LM	9536LM	18816LM
DELIVERED LUMENS - INDIRECT BATWING	9481LM	18630LM	8045LM	15814LM	9481LM	18630LM	10632LM	22527LM	10632LM	22527LM	11500LM	24803LM	13787LM	27079LM
DELIVERED LUMENS - INDIRECT LAMBERT	7614LM	14962LM	6461LM	12700LM	7614LM	14962LM	8539LM	18091LM	8539LM	18091LM	9235LM	19919LM	11072LM	21747LM
EFFICACY DIRECT	98LM/W	91LM/W	98LM/W	91LM/W	98LM/W	91LM/W	98LM/W	92LM/W	98LM/W	98LM/W	92LM/W	98LM/W	91LM/W	93LM/W
EFFICACY INDIRECT BATWING	142LM/W	132LM/W	142LM/W	132LM/W	142LM/W	132LM/W	141LM/W	131LM/W	142LM/W	131LM/W	142LM/W	131LM/W	141LM/W	131LM/W
EFFICACY INDIRECT LAMBERTIAN	114LM/W	106LM/W	114LM/W	106LM/W	114LM/W	106LM/W	114LM/W	106LM/W	114LM/W	106LM/W	114LM/W	106LM/W	114LM/W	106LM/W
OTHER INFORMATION														
WEIGHT OF FIXTURE	35.2LBS / 16KG		31.4LBS / 14.3KG		35.2LBS / 16KG		39LBS / 17.7KG		39LBS / 17.7KG		42.8LBS / 19.5KG		46.6LBS / 21.2KG	
L70 (LUMEN MAINTENANCE)	> 60 000 H		> 60 000 H		> 60 000 H		> 60 000 H		> 60 000 H		> 60 000 H		> 60 000 H	

EFFICACY MULTIPLIERS

CRIC	CT	FACTOR	TW FACTOR
80+	5000K	-	0.93
80+	4000K	-	1.00
80+	3500K	-	0.99
80+	3000K	-	0.98
80+	2700K	-	0.91
90+	4000K	1.00	-
90+	3500K	0.96	-
90+	3000K	0.92	-
90+	2700K	0.87	-

LIGHT DISTRIBUTION

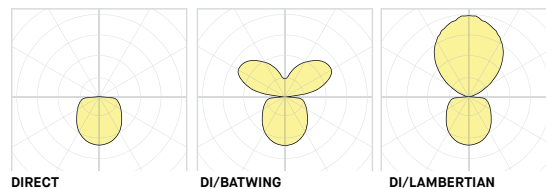

Visit our website for warranty terms and conditions.



TECHNICAL DATA

FAMILLE ÉTENDUE

Offert en 15 tailles polyvalentes.
Une infinité de combinaisons possibles.
Pour les petits aux plus grands espaces.

HAUTE PERFORMANCE

La lumière des bandes DEL est contrôlée par des réflecteurs efficaces à 98%, ce qui confère à l'ATOLL d'excellentes performances optiques et énergétiques. Sa lentille en silicone très efficace assure un éclairage performant et confortable.

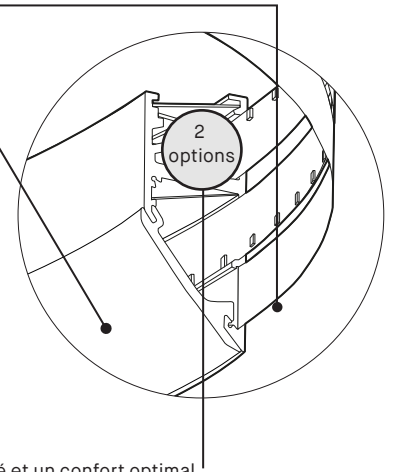
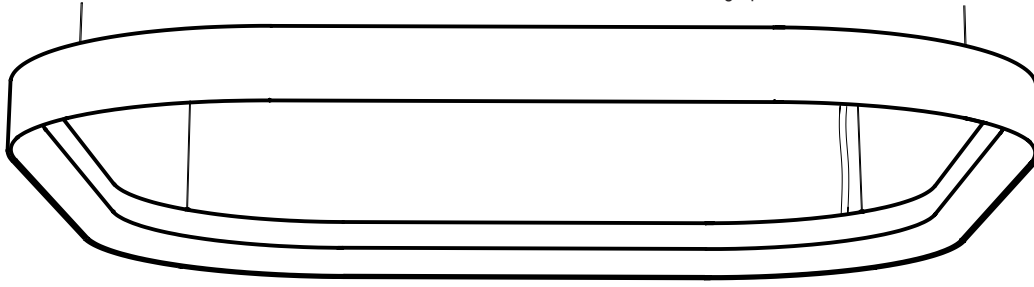

ÉCLAIRAGE ARCHITECTURAL

ATOLL offre deux options d'éclairage architectural indirect polyvalent, pour éclairer différents espaces avec une efficacité et un confort optimal

4850DI-B

OPTION BATWING

La lumière indirecte est contrôlée par des réflecteurs en aluminium qui crée une distribution batwing protégée de la poussière par une lentille clair. On obtient une illumination unie du plafond, même lorsque l'anneau est proche de celui-ci. Cette option est idéale pour les plafonds bas. Le luminaire doit être dissimulé lorsqu'on le regarde d'en haut et installé sans inclinaison.

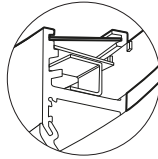

4850DI-L

OPTION LAMBERTIENNE

Une lentille en silicone, crée une lumière diffuse car sa texture de surface disperse la lumière de manière uniforme, réduisant l'éblouissement et répartissant l'illumination de manière homogène. Idéal pour une hauteur de montage au plafond de 36 pouces et plus; peut être visible d'en haut et suspendu à angle.

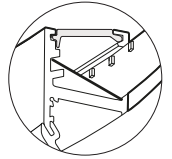

DISTANCE MINIMUM RECOMMANDÉE DU PLAFOND (par rapport au dessus de l'anneau)

COTÉ LE PLUS LONG	44	62	82	100	120
DISTANCE	10"	12"	12"	15"	18"

DISTANCE MINIMUM RECOMMANDÉE DU PLAFOND (par rapport au dessus de l'anneau)

GRANDEUR : TOUS
DISTANCE : 24" min. recommandé.

SPÉCIFICATION PRODUIT

	44X44		44X62		44X81		44X100		44X120		62X62		62X82		62X100	
PERFORMANCE (4000K)	REG	HO	REG	HO	REG	HO	REG	HO	REG	HO	REG	HO	REG	HO	REG	HO
PUISSANCE DIRECT	39.0W	79.2W	48.7W	99.6W	56.7W	120W	74.9W	158.4W	74.9W	158.4W	56.7W	120W	66.9W	141.5W	74.9W	158.4W
PUISSANCE INDIRECT	19.3W	39.6W	28.4W	60W	39.0W	79.2W	56.7W	120W	56.7W	120W	39W	79.2W	48.7W	99.6W	56.7W	120.0W
LUMENS RÉELS DIRECT (4000K)	3807LM	7215LM	4758LM	9065LM	5553LM	10916LM	7339LM	14429LM	7339LM	14429LM	5553LM	10916LM	6544LM	12860LM	7339LM	14429LM
LUMENS RÉELS INDIRECT BATWING(4K)	2729LM	5223LM	4023LM	7907LM	5515LM	5553LM	8045LM	15814LM	8045LM	15814LM	5515LM	10452LM	6893LM	13133LM	8045LM	15814LM
LUMENS RÉELS IND LAMBERTIEN (4K)	2192LM	4197LM	3230LM	6350LM	4429LM	8394LM	5536LM	10547LM	6461LM	12700LM	4429LM	8394LM	5536LM	10547LM	6461LM	12700LM
EFFICACITÉ DIRECT	98LM/W	91LM/W	98LM/W	91LM/W	98LM/W	91LM/W	98LM/W	91LM/W	98LM/W	91LM/W	98LM/W	91LM/W	98LM/W	91LM/W	98LM/W	91LM/W
EFFICACITÉ INDIRECT BATWING	142LM/W	132LM/W	142LM/W	132LM/W	141LM/W	132LM/W	141LM/W	132LM/W	141LM/W	132LM/W	141LM/W	132LM/W	141LM/W	132LM/W	142LM/W	132LM/W
EFFICACITÉ INDIRECT LAMBERTIENNE	114LM/W	106LM/W	114LM/W	106LM/W	114LM/W	106LM/W	114LM/W	106LM/W	114LM/W	106LM/W	114LM/W	106LM/W	114LM/W	106LM/W	114LM/W	106LM/W
AUTRES INFORMATIONS																
POIDS DU LUMINAIRE	16.2LBS / 7.4KG		20LBS / 9.1KG		23.8LBS / 10.8KG		27.6LBS / 12.5KG		31.4LBS / 14.3KG		23.8LBS / 10.8KG		27.6LBS / 12.5KG		31.4LBS / 14.3KG	
L70 (MAINTENANCE DE LA LUMIÈRE)	> 60 000 H		> 60 000 H		> 60 000 H		> 60 000 H		> 60 000 H		> 60 000 H		> 60 000 H		> 60 000 H	

SPÉCIFICATION PRODUIT

	62X120		82X82		81X100		82X120		100X100		100X120		120X120	
PERFORMANCE (4000K)	REG	HO	REG	HO	REG	HO	REG	HO	REG	HO	REG	HO	REG	HO
PUISSANCE DIRECT	85.1W	179.9W	74.9W	158.4W	80.8W	180W	88.9W	187.4W	88.9W	187.4W	93.7W	197.3W	96.4W	202.6W
PUISSANCE INDIRECT	66.9W	141.5W	56.7W	120W	66.9W	141.5W	74.9W	172.6W	74.9W	172.6W	80.8W	189.4W	97.5W	206.2W
LUMENS RÉELS DIRECT (4000K)	8330LM	16374LM	7339LM	14429LM	7938LM	16374LM	8733LM	17192LM	8733LM	17192LM	9233LM	18194LM	9536LM	18816LM
LUMENS RÉELS INDIRECT BATWING(4K)	9481LM	18630LM	8045LM	15814LM	9481LM	18630LM	10632LM	22527LM	10632LM	22527LM	11500LM	24803LM	13787LM	27079LM
LUMENS RÉELS IND LAMBERTIEN (4K)	7614LM	14962LM	6461LM	12700LM	7614LM	14962LM	8539LM	18091LM	8539LM	18091LM	9235LM	19919LM	11072LM	21747LM
EFFICACITÉ DIRECT	98LM/W	91LM/W	98LM/W	91LM/W	98LM/W	91LM/W	98LM/W	92LM/W	98LM/W	92LM/W	99LM/W	91LM/W	99LM/W	93LM/W
EFFICACITÉ INDIRECT BATWING	142LM/W	132LM/W	142LM/W	132LM/W	142LM/W	132LM/W	141LM/W	131LM/W	142LM/W	131LM/W	142LM/W	131LM/W	141LM/W	131LM/W
EFFICACITÉ INDIRECT LAMBERTIENNE	114LM/W	106LM/W	114LM/W	106LM/W	114LM/W	106LM/W	114LM/W	106LM/W	114LM/W	106LM/W	114LM/W	106LM/W	114LM/W	106LM/W
AUTRES INFORMATIONS														
POIDS DU LUMINAIRE	35.2LBS / 16KG		31.4LBS / 14.3KG		35.2LBS / 16KG		39LBS / 17.7KG		39LBS / 17.7KG		42.8LBS / 19.5KG		46.6LBS / 21.2KG	
L70 (MAINTENANCE DE LA LUMIÈRE)	> 60 000 H		> 60 000 H		> 60 000 H		> 60 000 H		> 60 000 H		> 60 000 H		> 60 000 H	

FACTEUR D'EFFICACITÉ

CRIC	CT	FACTOR	TW FACTOR
80+	5000K	-	0.93
80+	4000K	-	1.00
80+	3500K	-	0.99
80+	3000K	-	0.98
80+	2700K	-	0.91
90+	4000K	1.00	-
90+	3500K	0.96	-
90+	3000K	0.92	-
90+	2700K	0.87	-

DISTRIBUTION LUMINEUSE

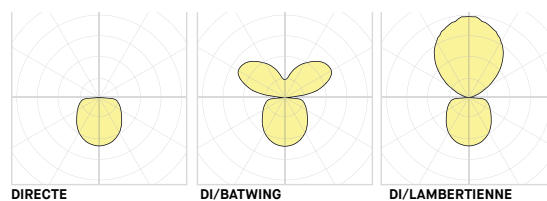



Visitez notre site Web pour les termes et conditions.

ATOLL - 4852 DIRECT, 3852/3853 SURFACE : CANOPY COMPATIBILITY CHART

DD : DUAL 0-10V DIMMING CONTROL FOR TUNABLE WHITE
 NT : NTUNE WIRELESS CONTROL FOR TUNABLE WHITE
 DP : PHASE DIMMING

BLANK SPACE = NOT AVAILABLE
 HO-REG OR REG-HO ARE EQUIVALENT IN THE CHART BELOW
 IC / NON-IC : NON-IC REMOTE BOXES CANNOT BE IN CONTACT WITHIN 3" OF INSULATION

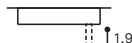
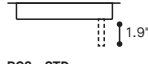
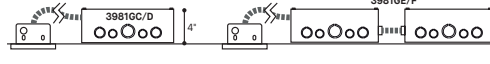
 FIXTURE	PHASE DIMMING OPTION	CANOPY								
		RC1	RC2	RC3			RC5 (RMP)			
		 RC1 Ø5.50" x 1.35" Ø140 x 34.3mm*	 RC2 - WIRED / AIR Ø7.75" x 1.30" Ø196.9 x 33mm*	 RC3 - STD RC3 - WIRED / AIR Ø9.4" x 1.88" Ø238.8 x 47.8mm*			 RC5 (RMP) 247IC 04.5" x 0.5" Ø114 x 13mm		RC5 (RMP) ACCESSORY 3981GC (IC), 3981GD (NON-IC) DRIVER REMOTE BOX 12" x 16" x 4" 305mm x 406mm x 100mm	
DIMENSIONS D = DIRECT, I = INDIRECT ILLUMINANCE : REG OR HO		COMPATIBILITY			FOR REMOTE LOCATION OR CAN BE REQUIRED TO FIT HIGHER POWER OR NLIGHT IF NOT AVAILABLE IN RC1,2,3,4		NLIGHT WIRED	TUNABLE WHITE		
STANDARD COMPACT CANOPY	NLIGHT WIRED OR AIR COMPACT CANOPY	STD HIGHER POWER	TUNABLE WHITE	NLIGHT WIRED OR AIR						
44X44 D - REG	DP	✓	✓		DD+NT		3981GC	✓	DD/NT	
44X44 D - HO				✓	DD		3981GC	✓	DD	
44X62 D - REG	DP	✓	✓		DD+NT		3981GC	✓	DD/NT	
44X62 D - HO				✓	DD		3981GC	✓	DD	
44X81 D - REG	DP			✓	DD+NT	✓	3981GC	✓	DD/NT	
44X81 D - HO	DP			✓	DD	✓	3981GC	✓	DD	
44X100 D - REG				✓	DD+NT		3981GC	✓	DD/NT	
44X100 D - HO				✓	DD		3981GC	✓	DD	
44X120 D - REG				✓	DD+NT		3981GC	✓	DD/NT	
44X120 D - HO				✓	DD		3981GC	✓	DD	
62X62 D - REG	DP			✓	DD+NT	✓	3981GC	✓	DD/NT	
62X62 D - HO	DP			✓	DD	✓	3981GC	✓	DD	
62X81 D - REG				✓	DD+NT		3981GC	✓	DD/NT	
62X81 D - HO				✓	DD		3981GC	✓	DD	
62X100 D - REG				✓	DD+NT		3981GC	✓	DD/NT	
62X100 D - HO				✓	DD		3981GC	✓	DD	
62X120 D - REG				✓	DD		3981GC	✓	DD	
62X120 D - HO				✓			NON-IC : 3981GD1 (120V) / 3981GD2 (277V)	✓		
81X81 D - REG				✓	DD+NT		3981GC	✓	DD/NT	
81X81 D - HO				✓	DDV		3981GC	✓	DD	
81X100 D - REG				✓	DD		3981GC	✓	DD	
81X100 D - HO				✓			NON-IC : 3981GD1 (120V) / 3981GD2 (277V)	✓		
81X120 D - REG				✓	DD		3981GC	✓	DD	
81X120 D - HO				✓			NON-IC : 3981GD1 (120V) / 3981GD2 (277V)	✓		
100X100 D - REG				✓	DD		3981GC	✓	DD	
100X100 D - HO				✓			NON-IC : 3981GD1 (120V) / 3981GD2 (277V)	✓		
100X120 D - REG				✓	DD		3981GC	✓	DD	
100X120 D - HO				✓			NON-IC : 3981GD1 (120V) / 3981GD2 (277V)	✓		
120X120 D - REG				✓	DD		3981GC	✓	DD	
120X120 D - HO				✓			NON-IC : 3981GD1 (120V) / 3981GD2 (277V)	✓		







SPECIFICATION

ATOLL - 4852/4853 PENDANT DIRECT-INDIRECT : CANOPY COMPATIBILITY CHART

DD : DUAL 0-10V DIMMING CONTROL FOR TUNABLE WHITE
 NT : NTUNE WIRELESS CONTROL FOR TUNABLE WHITE
 DP : PHASE DIMMING

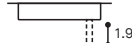
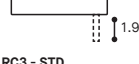
BLANK SPACE = NOT AVAILABLE
 HO-REG OR REG-HO ARE EQUIVALENT IN THE CHART BELOW
 IC / NON-IC : NON-IC REMOTE BOXES CANNOT BE IN CONTACT WITHIN 3" OF INSULATION

 FIXTURE	PHASE DIMMING OPTION	CANOPY											
		RC1	RC2	RC3			RC5 (RMP)						
		 RC1 Ø5.50" x 1.35" Ø140 x 34.3mm*	 RC2 - WIRED / AIR Ø7.75" x 1.30" Ø196.9 x 33mm*	 RC3 - STD RC3 - WIRED / AIR Ø9.4" x 1.88" Ø238.8 x 47.8mm*			 RC5 (RMP) 24710 04.5" x 0.5" Ø114 x 13mm			RC5 (RMP) ACCESSORY 3981GC (IC), 3981GD (NON-IC) DRIVER REMOTE BOX 12" x 16" x 4" 305mm x 406mm x 100mm			RC5 (RMP) ACCESSORY 3981GE (IC), 3981GF (NON-IC) DOUBLE DRIVER REMOTE BOX 12" x 31" x 4" 305mm x 787mm x 100mm
DIMENSIONS D = DIRECT, I = INDIRECT ILLUMINANCE : REG OR HO		COMPATIBILITY		FOR REMOTE LOCATION OR CAN BE REQUIRED TO FIT HIGHER POWER OR NLIGHT IF NOT AVAILABLE IN RC1,2,3,4				NLIGHT WIRED	TUNABLE WHITE				
44X44 DI - REG-REG	DP	✓	✓			DD			3981GC	✓		DD	
44X44 DI - REG-HO	DP	✓	✓			DD			3981GC	✓		DD	
44X44 DI - HO-REG				✓					3981GC	✓			
44X44 DI - HO-HO				✓					3981GC	✓			
44X62 DI - REG-REG	DP	✓	✓			DD			3981GC	✓		DD	
44X62 DI - REG-HO	DP			✓	DD	✓			3981GC	✓		DD	
44X62 DI - HO-REG				✓					3981GC	✓			
44X62 DI - HO-HO				✓					NON-IC : 3981GD1 (120V) / 3981GD2 (277V)	✓			
44X81 DI - REG-REG	DP			✓	DD	✓			3981GC	✓		DD	
44X81 DI - REG-HO				✓					3981GC	✓			
44X81 DI - HO-REG	DP			✓		✓			3981GC	✓			
44X81 DI - HO-HO									IC DOUBLE BOX 3981GE	✓			
44X100 DI - REG-REG				✓	DD				3981GC	✓		DD	
44X100 DI - REG-HO				✓					NON-IC : 3981GD1 (120V) / 3981GD2 (277V)	✓			
44X100 DI - HO-REG				✓		✓			IC DOUBLE BOX 3981GE	✓			
44X100 DI - HO-HO									IC DOUBLE BOX 3981GE	✓			
44X120 DI - REG-REG				✓	DD	✓			3981GC	✓		DD	
44X120 DI - REG-HO									IC DOUBLE BOX 3981GE	✓			
44X120 DI - HO-REG									IC DOUBLE BOX 3981GE	✓			
44X120 DI - HO-HO									IC DOUBLE BOX 3981GE	✓			
62X62 DI - REG-REG	DP			✓	DD	✓			3981GC	✓		DD	
62X62 DI - REG-HO				✓					NON-IC : 3981GD1 (120V) / 3981GD2 (277V)	✓			
62X62 DI - HO-REG	DP			✓		✓			IC DOUBLE BOX 3981GE	✓			
62X62 DI - HO-HO									IC DOUBLE BOX 3981GE	✓			
62X81 DI - REG-REG				✓	DD				3981GC	✓		DD	
62X81 DI - REG-HO				✓					3981GC	✓			
62X81 DI - HO-REG									IC DOUBLE BOX 3981GE	✓			
62X81 DI - HO-HO									IC DOUBLE BOX 3981GE	✓			
62X100 DI - REG-REG				✓	DD				3981GC	✓		DD	
62X100 DI - REG-HO									3981GC	✓			
62X100 DI - HO-REG									IC DOUBLE BOX 3981GE	✓			
62X100 DI - HO-HO									IC DOUBLE BOX 3981GE	✓			
62X120 DI - REG-REG				✓					NON-IC : 3981GD1 (120V) / 3981GD2 (277V)	✓			
62X120 DI - REG-HO									IC DOUBLE BOX 3981GE	✓			
62X120 DI - HO-REG									NON-IC DOUBLE BOX 3981GF1 (120V) / 3981GF2 (277V)	✓			
62X120 DI - HO-HO									NON-IC DOUBLE BOX 3981GF1 (120V) / 3981GF2 (277V)	✓			
81X81 DI - REG-REG				✓	DD				3981GC	✓		DD	
81X81 DI - REG-HO									IC DOUBLE BOX 3981GE	✓			
81X81 DI - HO-REG									IC DOUBLE BOX 3981GE	✓			
81X81 DI - HO-HO									IC DOUBLE BOX 3981GE	✓			
81X100 DI - REG-REG				✓					3981GC	✓			
81X100 DI - REG-HO									IC DOUBLE BOX 3981GE	✓			
81X100 DI - HO-REG									NON-IC DOUBLE BOX 3981GF1 (120V) / 3981GF2 (277V)	✓			
81X100 DI - HO-HO									NON-IC DOUBLE BOX 3981GF1 (120V) / 3981GF2 (277V)	✓			
81X120 DI - REG-REG				✓					NON-IC : 3981GD1 (120V) / 3981GD2 (277V)	✓			
81X120 DI - REG-HO									IC DOUBLE BOX 3981GE	✓			
81X120 DI - HO-REG									NON-IC DOUBLE BOX 3981GF1 (120V) / 3981GF2 (277V)	✓			
81X120 DI - HO-HO									NON-IC DOUBLE BOX 3981GF1 (120V) / 3981GF2 (277V)	✓			
100X100 DI - REG-REG				✓					NON-IC : 3981GD1 (120V) / 3981GD2 (277V)	✓			
100X100 DI - REG-HO									IC DOUBLE BOX 3981GE	✓			
100X100 DI - HO-REG									NON-IC DOUBLE BOX 3981GF1 (120V) / 3981GF2 (277V)	✓			
100X100 DI - HO-HO									NON-IC DOUBLE BOX 3981GF1 (120V) / 3981GF2 (277V)	✓			
100X120 DI - REG-REG				✓					NON-IC : 3981GD1 (120V) / 3981GD2 (277V)	✓			
100X120 DI - REG-HO									NON-IC : 3981GD1 (120V) / 3981GD2 (277V)	✓			
100X120 DI - HO-REG									NON-IC DOUBLE BOX 3981GF1 (120V) / 3981GF2 (277V)	✓			
100X120 DI - HO-HO									NON-IC DOUBLE BOX 3981GF1 (120V) / 3981GF2 (277V)	✓			
120X120 DI - REG-REG				✓					NON-IC : 3981GD1 (120V) / 3981GD2 (277V)	✓			
120X120 DI - REG-HO									NON-IC DOUBLE BOX 3981GF1 (120V) / 3981GF2 (277V)	✓			
120X120 DI - HO-REG									NON-IC DOUBLE BOX 3981GF1 (120V) / 3981GF2 (277V)	✓			
120X120 DI - HO-HO									NON-IC DOUBLE BOX 3981GF1 (120V) / 3981GF2 (277V)	✓			