

# CALDERA 3046

PROJECT PROJET
SPEC TYPE
NOTES

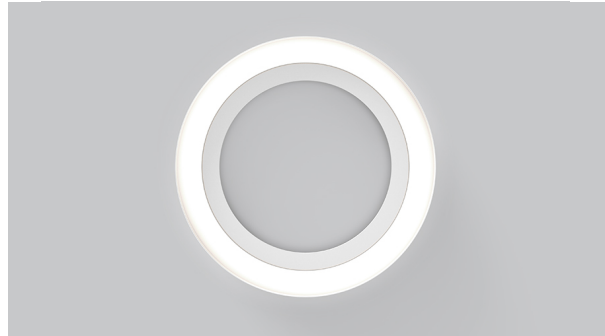

## FINISH FINI



BLKE



WHE

## FAMILY FAMILLE



3046-28 (WALL SURFACE)



3046-46 (WALL SURFACE)



3046-28 (CEILING SURFACE)



3046-46 (CEILING SURFACE)



4246-28



4246-46

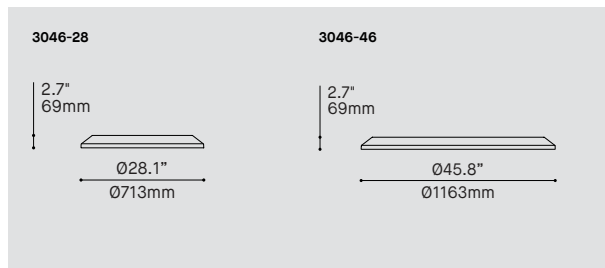

## ORDERING SPECIFICATION SPÉCIFICATION DE COMMANDE

CODE

### MODEL MODÈLE

3046-28 CALDERA 28"  
3046-46 CALDERA 46"

### LIGHT SOURCE SOURCE LUMINEUSE

LED REGULAR OUTPUT  
LED.HO HIGH OUTPUT  
LED.SHO\* SUPER HIGH OUTPUT  
\* ONLY FOR 3046-28

### COLOR TEMPERATURE TEMPÉRATURE DE COULEUR

27\* 2700K  
30 3000K  
35 3500K  
40 4000K  
\* LONGER LEAD TIME MAY APPLY, PLEASE CONTACT YOUR EUREKA REPRESENTATIVE

### COLOR RENDERING INDEX (CRI) INDICE DE RENDU DE COULEUR (IRC)

80 80+ CRI  
90\* 90+ CRI  
\* LONGER LEAD TIME MAY APPLY, PLEASE CONTACT YOUR EUREKA REPRESENTATIVE

### VOLTAGE VOLTAGE

120V 120 VOLT  
277V 277 VOLT

### CONTROL OPTION OPTION DE CONTRÔLE

DV 0-10V DIMMING (120V-277V)  
DP PHASE DIMMING (120V ONLY)  
LED DIMMING DRIVER IS STANDARD IN THIS PRODUCT, PLEASE SPECIFY YOUR DIMMING TYPE.

### EMERGENCY BATTERY BATTERIE D'URGENCE

EM DRIVER BOX INCLUDED, INSTALLED REMOTELY. SEE EM GUIDE FOR DETAILS.  
EMB\* EMERGENCY BATTERY FOR REMOTE BOX  
\* 3981E ACCESSORY IS REQUIRED FOR THIS OPTION

### MOUNTING MONTAGE

SL\* SLIM RECTANGULAR MOUNTING HOLE (NO PLATE)  
RO\*\* COVER FOR EXISTING STANDARD 4" HOLE (D-SHAPED PLATE)  
\* REFER TO INSTALLATION DOCUMENT FOR HOLE DIMENSIONS  
\*\* EXISTING JUNCTION BOX MUST BE REMOVED AND REPLACED WITH ONE PROVIDED

### EXTERIOR SHADE FINISH FINI ABAT-JOUR EXTÉRIEUR (A)

BLKE BLACK FINE TEXTURE  
WHE WHITE FINE TEXTURE  
RAL\* PLEASE SPECIFY RAL CODE  
\* LONGER LEAD TIME MAY APPLY, PLEASE CONTACT YOUR EUREKA REPRESENTATIVE  
(A) SHADE INTERIOR IS ALWAYS WHITE

### EMERGENCY BATTERY ACCESSORY ACCESSOIRE BATTERIE D'URGENCE

3981EA ELECTRICAL BOX FOR EMB EMERGENCY BATTERY

## PRODUCT CHARACTERISTICS CARACTÉRISTIQUES DU PRODUIT



<b>DESIGN:</b>	A sleek and narrow profile with a large hollow center allows Caldera to harmonize gracefully with its surroundings, while its sharper and refined silhouette adds an elegant aesthetic touch to any space.
<b>INSTALLATION:</b>	Simple and discreet « twist & lock » installation system. Available with additional plate to cover existing standard junction box hole. (ADA compliant).
<b>LIGHT SOURCE:</b>	An enveloping halo of light with minimal glare emerges from the invisible light source, hidden within the central ring. Offered with phase, 0-10V dimming. Emergency option also available.
<b>SHADE:</b>	An aluminium construction coated with a high-quality fine texture paint.
<b>CONCEPTION:</b>	Un profil étroit et épuré ainsi qu'un centre ouvert permettent à Caldera de s'harmoniser avec grâce à son environnement, alors que sa silhouette angulaire et raffinée ajoute une touche visuelle élégante à tout espace.
<b>INSTALLATION:</b>	Installation avec système « twist & lock » simple et discret. Disponible avec plaque additionnelle pour couvrir trou de boîte de jonction standard. (Conforme à l'ADA).
<b>SOURCE LUMINEUSE:</b>	Un halo de lumière enveloppant et sans éblouissement émerge d'une source lumineuse dissimulée dans l'anneau central. Offert avec gradation de type phase ou 0-10V. Batterie d'urgence disponible.
<b>ABAT-JOUR:</b>	Construction en aluminium, recouverte d'une peinture finement texturée de haute qualité.

# CALDERA 3046 / 4246

## CANOPY POSITION

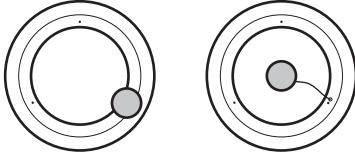
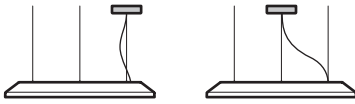

**4246-XX**  
Canopy on  
mounting point (STD)

**4246-XX RCC**  
Canopy centered  
with luminaire

## WEIGHTLESS FORM

With its thin profile and hollowed center, allowing you to see through the fixture's core, Caldera seems to float in space.

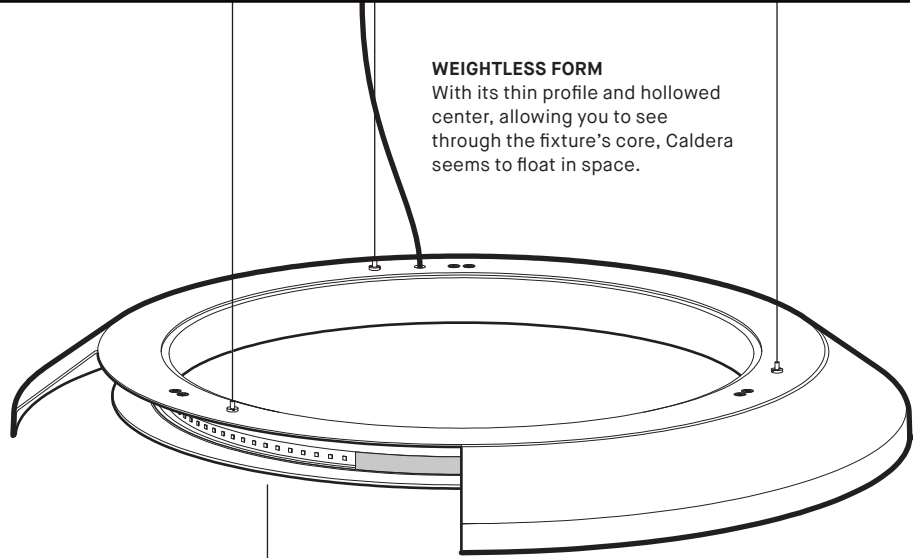

## DISCREET ILLUMINATION

A thin lens wrapped around the LEDs helps create a softer illumination while retaining a high efficiency. The light source, hidden within the ring's cavity, is invisible from every angle allowing a minimal glare experience.

The conical shaped shade redirects light downwards to create an ambient illumination. Offered in two different diameters: 28" & 46".



## MINIMAL SURFACE MOUNTING

With a depth of 2.7", Caldera is ADA compliant when installed on a wall.

Remote junction box(es) are provided with every surface mounted fixture.

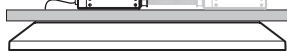

## ADAPTABLE

Caldera is available in 2 surface mount options: installed on a rectangular cutout with no visible hardware or on an existing 4" hole with a cover plate (provided).

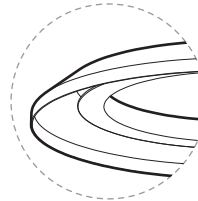

RECTANGULAR CUTOUT  
Seamless, new installation



STANDARD 4" HOLE  
Discreet plate, retrofit installation

## PRODUCT SPECIFICATION

### XX46-28

### XX46-46

PERFORMANCE	REG	HO	SHO	TW REG	TW HO	REG	HO	TW REG
SYSTEM WATTAGE	25.0W	52.5W	82.0W	25.0W	52.3W	49.9W	104.9W	50.0W
DELIVERED LUMENS (4000K)	1960LM	3635LM	5125LM	1740LM	3125LM	3825LM	6900LM	3325LM
EFFICACY	80LM/W	69LM/W	62LM/W	69LM/W	60LM/W	76LM/W	66LM/W	66LM/W

## OTHER INFORMATION

LUMINAIRE'S WEIGHT	10LBS / 4.5KG					16LBS / 7.2KG		
L70 (LUMEN MAINTENANCE) REG/HO/SHO	60,000					60,000		

## WELL STANDARD REQUIREMENTS

MAX. LUMINANCE 450-900 OF NADIR	200 CD/M <sup>2</sup> (AT HO)					150 CD/M <sup>2</sup> (AT HO)		
LIGHT QUALITY	R9 > 50 (90 CRI OPTION)					R9 > 50 (90 CRI OPTION)		
FLICKERING TOLERANCE	LOW FLICKER, COMPLIANT TO CALIFORNIA TITLE 24					LOW FLICKER, COMPLIANT TO CALIFORNIA TITLE 24		

## EFFICACY MULTIPLIERS

CRI	CCT	FACTOR
80+	4000K	1.00
80+	3500K	0.98
80+	3000K	0.94
80+	2700K	0.91
90+	4000K	0.88
90+	3500K	0.85
90+	3000K	0.81
90+	2700K	0.77

## LIGHT DISTRIBUTION

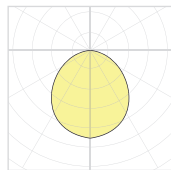

XX46-28

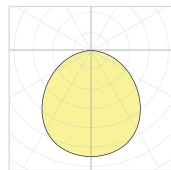

XX46-46



Visit our website for warranty terms and conditions.



## TECHNICAL DATA

## POSITION PAVILLON

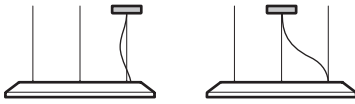

**4246-XX**  
Pavillon au point de montage (STD)

**4246-XX RCC**  
Pavillon au centre du luminaire

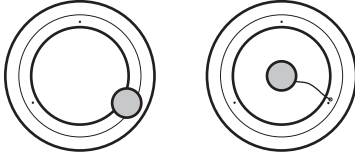

## FORME DÉLICATE

Avec son profil mince et centre vide, vous permettant de voir au travers du luminaire, Caldera semble flotter dans l'espace.

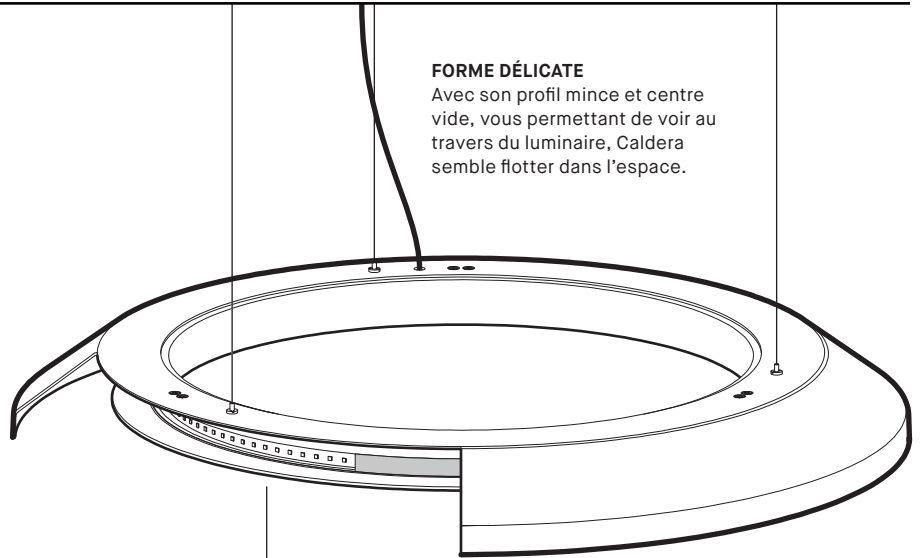

## ILLUMINATION DISCRÈTE

Une lentille mince enveloppée autour des LEDs aide à produire une lumière plus douce en retenant une haute efficacité. La source lumineuse, cachée à l'intérieur de l'anneau, est invisible de tous les angles, permettant une vue avec peu d'éblouissement.

L'abat-jour de forme conique redirige la lumière vers le bas pour créer un éclairage ambiant. Offert en deux diamètres: 28" & 46".



## MONTAGE SURFACE MINIMALE

Avec une profondeur de 2.7", Caldera est conforme à la norme ADA lorsqu'installé au mur.

Boîte(s) de jonction remote sont fourni avec toutes fixitures surface.

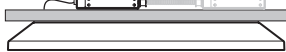

## ADAPTABLE

offert avec 2 options de montage surface: installé sur une découpe rectangulaire avec aucune quincaillerie visible ou sur un trou de 4" existant avec une plaque (fourni).

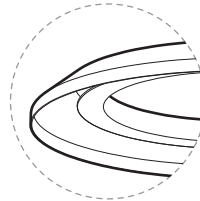

DÉCOUPE RECTANGULAIRE  
Uniforme, nouvelle installation



TROU STANDARD 4"  
Plaque discrète, installation réaménagée

## SPÉCIFICATION PRODUIT

### XX46-28

### XX46-46

PERFORMANCE	REG	HO	SHO	TW REG	TW HO	REG	HO	TW REG
PUISSANCE TOTALE	25.0W	52.5W	82.0W	25.0W	52.3W	49.9W	104.9W	50.0W
LUMENS RÉELS (4000K)	1960LM	3635LM	5125LM	1740LM	3125LM	3825LM	6900LM	3325LM
EFFICACITÉ	80LM/W	69LM/W	62LM/W	69LM/W	60LM/W	76LM/W	66LM/W	66LM/W

## AUTRES INFORMATION

POIDS PAR TÊTE 10LBS / 4.5KG  
L70 (MAINTENANCE DE LA LUMIÈRE) REG/HO/SHO 60,000

16LBS / 7.2KG  
60,000

## CRITÈRES DE CERTIFICATION WELL

MAX. LUMINANCE 450-900 NADIR 200 CD/M<sup>2</sup> (EN HO)  
R9 > 50 (OPTION 90 IRC)  
QUALITÉ DE LA LUMIÈRE R9 > 50 (OPTION 90 IRC)  
TOLÉRANCE DE CLIGNOTEMENT PEU DE CLIGNOTEMENT (CONFORME À CALIFORNIA TITLE 24)

150 CD/M<sup>2</sup> (EN HO)  
R9 > 50 (OPTION 90 IRC)  
PEU DE CLIGNOTEMENT (CONFORME À CALIFORNIA TITLE 24)

## FACTEUR D'EFFICACITÉ

IRC	CCT	FACTEUR
80+	4000K	1.00
80+	3500K	0.98
80+	3000K	0.94
80+	2700K	0.91
90+	4000K	0.88
90+	3500K	0.85
90+	3000K	0.81
90+	2700K	0.77

## DISTRIBUTION LUMINEUSE

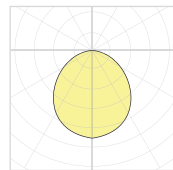

XX46-28

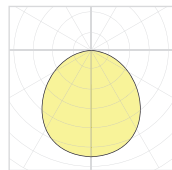

XX46-46



Visitez notre site Web pour les termes et conditions.