

CALDERA 4246 PENDANT

PROJECT PROJÉT
SPEC TYPE
NOTES



FINISH FINI



BLKE



WHE

FAMILY FAMILLE



3046-28 (WALL SURFACE)

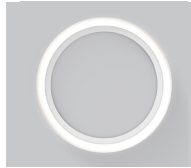

3046-46 (WALL SURFACE)



3046-28 (CEILING SURFACE)



3046-46 (CEILING SURFACE)



4246-28



4246-46

MOUNTING MONTAGE

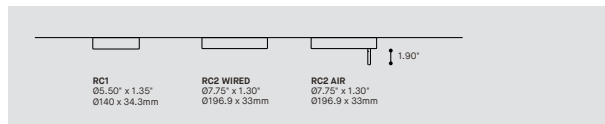

MOUNTING CABLE OPTION OPTION DE MONTAGE CÂBLE

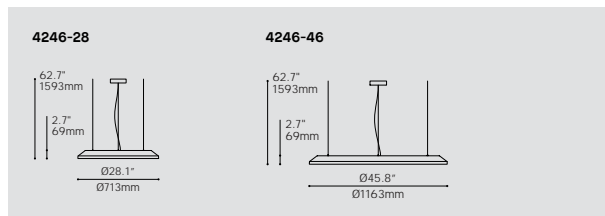

ORDERING SPECIFICATION SPÉCIFICATION DE COMMANDE

CODE

MODEL MODÈLE

4246-28 CALDERA 28"
 4246-46 CALDERA 46"

LIGHT SOURCE SOURCE LUMINEUSE

LED REGULAR OUTPUT
 LED.HO HIGH OUTPUT
 LED.SHO* SUPER HIGH OUTPUT
 * ONLY FOR 4246-28

COLOR TEMPERATURE TEMPÉRATURE DE COULEUR

27* 2700K
 30 3000K
 35 3500K
 40 4000K
 * LONGER LEAD TIME MAY APPLY, PLEASE CONTACT YOUR EUREKA REPRESENTATIVE

COLOR RENDERING INDEX (CRI) INDICE DE RENDU DE COULEUR (IRC)

80 80+ CRI
 90* 90+ CRI
 * LONGER LEAD TIME MAY APPLY, PLEASE CONTACT YOUR EUREKA REPRESENTATIVE

VOLTAGE VOLTAGE

120V 120 VOLT
 277V 277 VOLT

CONTROL OPTION OPTION DE CONTRÔLE

DV 0-10V DIMMING (120V-277V)
 DP PHASE DIMMING (120V ONLY)
 NLTAIR2* NLIGHT AIR CONTROL GEN 2
 NLIGHT* NLIGHT WIRED CONTROL
 * REQUIRES RC2 CANOPY
 * EMERGENCY BATTERY NOT AVAILABLE WITH NLIGHT OPTIONS
 REFER TO NLIGHT GUIDE AND INSTALLATION SHEET FOR ALL REQUIREMENTS

EMERGENCY BATTERY BATTERIE D'URGENCE

EM DRIVER BOX INCLUDED, INSTALLED REMOTELY, SEE EM GUIDE FOR DETAILS.
 EMB* EMERGENCY BATTERY FOR REMOTE BOX
 * 3981E ACCESSORY IS REQUIRED FOR THIS OPTION

CABLE CÂBLE

AC AIRCRAFT MOUNTING AND BLACK OR WHITE CABLE, FIELD ADJUSTABLE

AC

CABLE LENGTH LONGUEUR DE CÂBLE

60 60" AIRCRAFT CABLE (STD LENGTH)
 ** CUSTOM AIRCRAFT CABLE LENGTH (PLEASE SPECIFY)
 FOR OVERALL LENGTH PLEASE CONTACT YOUR EUREKA REPRESENTATIVE

MOUNTING MONTAGE

RC1 SCREWLESS CANOPY 05.50" X 1.35" (2473F)
 RC2 NLIGHT SCREWLESS CANOPY 07.75" X 1.30" (2474H)

MOUNTING CABLE OPTION OPTION DE MONTAGE DE CÂBLE

RCC CENTERED ROUND CANOPY - STRAIGHT AIRCRAFT CABLES
 IF NO OPTION IS SELECTED, AN OFF-CENTERED ROUND CANOPY WITH STRAIGHT AIRCRAFT CABLES IS STANDARD

CANOPY FINISH FINI PAVILLON

BLKE BLACK FINE TEXTURE
 WHE WHITE FINE TEXTURE

POWER CORD FINISH FINI CÂBLE D'ALIMENTATION

BLK BLACK POWER CORD
 WH WHITE POWER CORD

EXTERIOR SHADE FINISH FINI ABAT-JOUR EXTÉRIEUR (A)

BLKE BLACK FINE TEXTURE
 WHE WHITE FINE TEXTURE
 RAL* PLEASE SPECIFY RAL CODE
 * LONGER LEAD TIME MAY APPLY, PLEASE CONTACT YOUR EUREKA REPRESENTATIVE
 (A) SHADE INTERIOR IS ALWAYS WHITE

ACCESSORY EMERGENCY BATTERY ACCESSOIRE BATTERIE D'URGENCE

3981EA ELECTRICAL BOX FOR EMB EMERGENCY BATTERY

PRODUCT CHARACTERISTICS CARACTÉRISTIQUES DU PRODUIT



SPECIFICATION

CALDERA 3046 / 4246

CANOPY POSITION

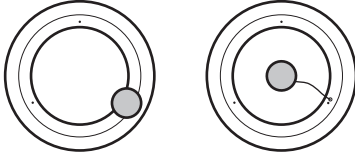
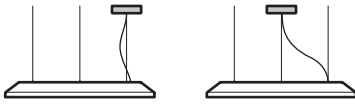

4246-XX
Canopy on
mounting point (STD)

4246-XX RCC
Canopy centered
with luminaire

WEIGHTLESS FORM

With its thin profile and hollowed center, allowing you to see through the fixture's core, Caldera seems to float in space.

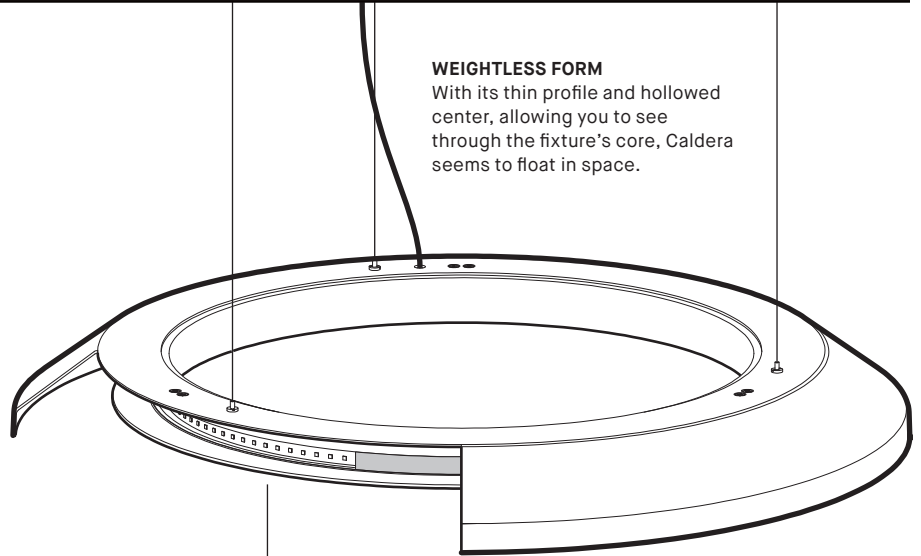

DISCREET ILLUMINATION

A thin lens wrapped around the LEDs helps create a softer illumination while retaining a high efficiency. The light source, hidden within the ring's cavity, is invisible from every angle allowing a minimal glare experience.

The conical shaped shade redirects light downwards to create an ambient illumination. Offered in two different diameters: 28" & 46".



MINIMAL SURFACE MOUNTING

With a depth of 2.7", Caldera is ADA compliant when installed on a wall.

Remote junction box(es) are provided with every surface mounted fixture.

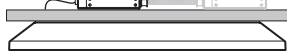

ADAPTABLE

Caldera is available in 2 surface mount options: installed on a rectangular cutout with no visible hardware or on an existing 4" hole with a cover plate (provided).

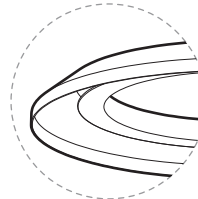

RECTANGULAR CUTOUT
Seamless, new installation



STANDARD 4" HOLE
Discreet plate, retrofit installation

PRODUCT SPECIFICATION

XX46-28

XX46-46

PERFORMANCE	REG	HO	SHO	TW REG	TW HO	REG	HO	TW REG
SYSTEM WATTAGE	25.0W	52.5W	82.0W	25.0W	52.3W	49.9W	104.9W	50.0W
DELIVERED LUMENS (4000K)	1960LM	3635LM	5125LM	1740LM	3125LM	3825LM	6900LM	3325LM
EFFICACY	80LM/W	69LM/W	62LM/W	69LM/W	60LM/W	76LM/W	66LM/W	66LM/W

OTHER INFORMATION

LUMINAIRE'S WEIGHT	10LBS / 4.5KG					16LBS / 7.2KG		
L70 (LUMEN MAINTENANCE) REG/HO/SHO	60,000					60,000		

WELL STANDARD REQUIREMENTS

MAX. LUMINANCE 450-900 OF NADIR	200 CD/M ² (AT HO)					150 CD/M ² (AT HO)		
LIGHT QUALITY	R9 > 50 (90 CRI OPTION)					R9 > 50 (90 CRI OPTION)		
FLICKERING TOLERANCE	LOW FLICKER, COMPLIANT TO CALIFORNIA TITLE 24					LOW FLICKER, COMPLIANT TO CALIFORNIA TITLE 24		

EFFICACY MULTIPLIERS

CRI	CCT	FACTOR
80+	4000K	1.00
80+	3500K	0.98
80+	3000K	0.94
80+	2700K	0.91
90+	4000K	0.88
90+	3500K	0.85
90+	3000K	0.81
90+	2700K	0.77

LIGHT DISTRIBUTION

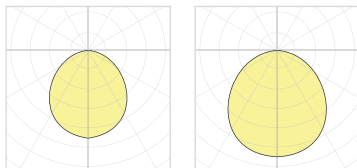

XX46-28

XX46-46



Visit our website for warranty terms and conditions.



TECHNICAL DATA

POSITION PAVILLON

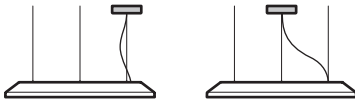

4246-XX
Pavillon au point de montage (STD)

4246-XX RCC
Pavillon au centre du luminaire

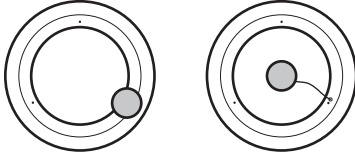

FORME DÉLICATE

Avec son profil mince et centre vide, vous permettant de voir au travers du luminaire, Caldera semble flotter dans l'espace.

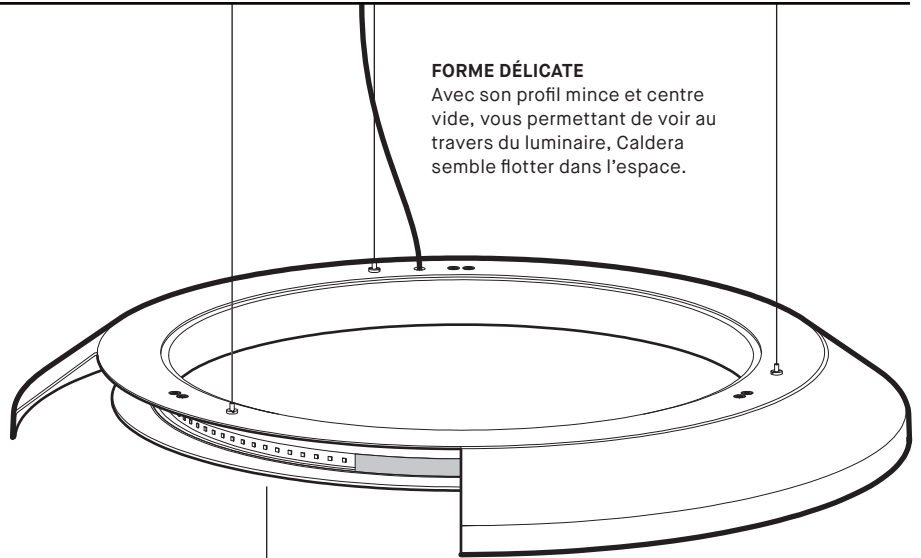

ILLUMINATION DISCRÈTE

Une lentille mince enveloppée autour des LEDs aide à produire une lumière plus douce en retenant une haute efficacité. La source lumineuse, cachée à l'intérieur de l'anneau, est invisible de tous les angles, permettant une vue avec peu d'éblouissement.

L'abat-jour de forme conique redirige la lumière vers le bas pour créer un éclairage ambiant. Offert en deux diamètres: 28" & 46".



MONTAGE SURFACE MINIMALE

Avec une profondeur de 2.7", Caldera est conforme à la norme ADA lorsqu'installé au mur.

Boîte(s) de jonction remote sont fourni avec toutes fixitures surface.

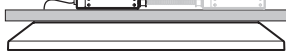

ADAPTABLE

offert avec 2 options de montage surface: installé sur une découpe rectangulaire avec aucune quincaillerie visible ou sur un trou de 4" existant avec une plaque (fourni).

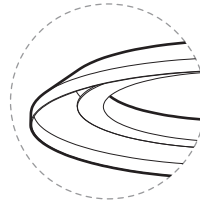

DÉCOUPE RECTANGULAIRE
Uniforme, nouvelle installation



TROU STANDARD 4"
Plaque discrète, installation réaménagée

SPÉCIFICATION PRODUIT

XX46-28

XX46-46

PERFORMANCE	REG	HO	SHO	TW REG	TW HO	REG	HO	TW REG
PUISSANCE TOTALE	25.0W	52.5W	82.0W	25.0W	52.3W	49.9W	104.9W	50.0W
LUMENS RÉELS (4000K)	1960LM	3635LM	5125LM	1740LM	3125LM	3825LM	6900LM	3325LM
EFFICACITÉ	80LM/W	69LM/W	62LM/W	69LM/W	60LM/W	76LM/W	66LM/W	66LM/W

AUTRES INFORMATION

POIDS PAR TÊTE 10LBS / 4.5KG
L70 (MAINTENANCE DE LA LUMIÈRE) REG/HO/SHO 60,000

16LBS / 7.2KG
60,000

CRITÈRES DE CERTIFICATION WELL

MAX. LUMINANCE 450-900 NADIR 200 CD/M² (EN HO)
R9 > 50 (OPTION 90 IRC)
QUALITÉ DE LA LUMIÈRE R9 > 50 (OPTION 90 IRC)
TOLÉRANCE DE CLIGNOTEMENT PEU DE CLIGNOTEMENT (CONFORME À CALIFORNIA TITLE 24)

150 CD/M² (EN HO)
R9 > 50 (OPTION 90 IRC)
PEU DE CLIGNOTEMENT (CONFORME À CALIFORNIA TITLE 24)

FACTEUR D'EFFICACITÉ

IRC	CCT	FACTEUR
80+	4000K	1.00
80+	3500K	0.98
80+	3000K	0.94
80+	2700K	0.91
90+	4000K	0.88
90+	3500K	0.85
90+	3000K	0.81
90+	2700K	0.77

DISTRIBUTION LUMINEUSE

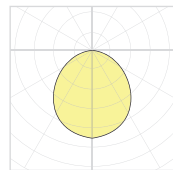

XX46-28

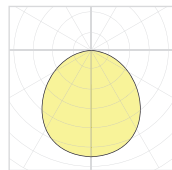

XX46-46



Visitez notre site Web pour les termes et conditions.