

HEX AREA 4821

PROJECT PROJCT
SPEC TYPE
NOTES

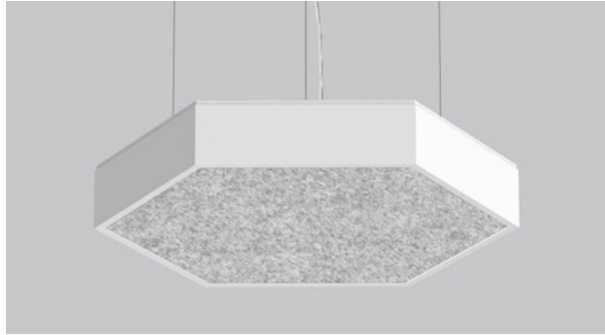

FINISH FINI



BLKE-CHF WHE-SGF LGE-SGF

FELT FINISH FINI FEUTRE



ADDITIONAL PREMIUM COLORS AVAILABLE – SEE ACOUSTIC MATERIAL COLOR OPTIONS PAGE

FAMILY FAMILLE



4721 (WALL SURFACE) 4720 (CEILING SURFACE) 4820



4715 (WALL SURFACE) 4715 (CEILING SURFACE) 4816

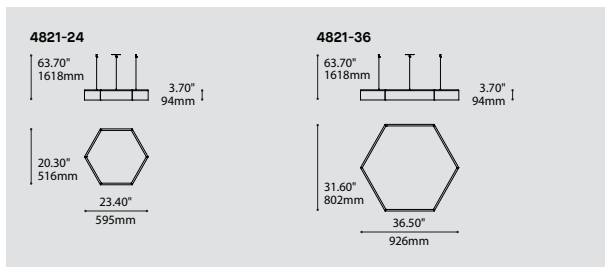

ORDERING SPECIFICATION SPÉCIFICATION DE COMMANDE

CODE

MODEL MODÈLE

4821-24	HEX AREA 24" – ACOUSTIC (NO LIGHT SOURCE)
4821I-24	HEX AREA 24" – ACOUSTIC WITH INDIRECT LIGHT SOURCE
4821-36	HEX AREA 36" – ACOUSTIC (NO LIGHT SOURCE)
4821I-36	HEX AREA 36" – ACOUSTIC WITH INDIRECT LIGHT SOURCE

LIGHT SOURCE SOURCE LUMINEUSE

AVAILABLE FOR 4821I ONLY	
LED	REGULAR OUTPUT INDIRECT
LED.HO	HIGH OUTPUT INDIRECT

COLOR TEMPERATURE TEMPÉRATURE DE COULEUR

27*	2700K
30	3000K
35	3500K
40	4000K
* LONGER LEAD TIME MAY APPLY. PLEASE CONTACT YOUR EUREKA REPRESENTATIVE	

COLOR RENDERING INDEX (CRI) INDICE DE RENDU DE COULEUR (IRC)

80	80+ CRI
90*	90+ CRI
* LONGER LEAD TIME MAY APPLY. PLEASE CONTACT YOUR EUREKA REPRESENTATIVE	

VOLTAGE VOLTAGE

120V	120 VOLT
277V	277 VOLT

CONTROL OPTION OPTION DE CONTRÔLE

AVAILABLE FOR 4821I ONLY	
DV	0-10V DIMMING (120V-277V)
DP	PHASE DIMMING (120V ONLY)
NLTAIR2*	NLIGHT AIR CONTROL GEN 2
NLIGHT*	NLIGHT WIRED CONTROL
* NLIGHT INTEGRATION REQUIRES A REMOTE POWER PACK (39NLAA FOR NLTAIR2 OR 39NLWA FOR NLIGHT).	
* NLIGHT WITH EMERGENCY BATTERY PLEASE CONTACT YOUR EUREKA REPRESENTATIVE.	
REFER TO NLIGHT GUIDE AND INSTALLATION SHEET FOR ALL REQUIREMENTS.	

CABLE CABLE

AC	AIRCRAFT MOUNTING & CLEAR CABLE, FIELD ADJUSTABLE
----	---------------------------------------------------

AC

CABLE LENGTH LONGUEUR DE CABLE

60	60" AIRCRAFT CABLE (STD LENGTH)
**	CUSTOM AIRCRAFT CABLE LENGTH (PLEASE SPECIFY)
FOR OVERALL LENGTH, PLEASE CONTACT YOUR EUREKA REPRESENTATIVE.	

MOUNTING MONTAGE

ROUND CANOPY / PAVILLON ROND	
RCA*	CENTERED ROUND CANOPY – AIRCRAFT CABLES ANGLED TO CENTER
RC	SCREWLESS 0.5" CANOPY (2471C)
* IF NO OPTION IS SELECTED, A ROUND CANOPY WITH STRAIGHT AIRCRAFT CABLES WILL BE PROVIDED.	
* ONLY AVAILABLE FOR 4821I	

CANOPY FINISH FINI PAVILLON (A)

BLKE	BLACK FINE TEXTURE
WHE	WHITE FINE TEXTURE
RAL*	PLEASE SPECIFY RAL CODE
* LONGER LEAD TIME MAY APPLY. PLEASE CONTACT YOUR EUREKA REPRESENTATIVE.	
(A) ONLY REQUIRED FOR 4821I	

HOUSING FINISH FINI BOITIER

BLKE	BLACK FINE TEXTURE
WHE	WHITE FINE TEXTURE
LGE	LIGHT GREY FINE TEXTURE
RAL*	PLEASE SPECIFY RAL CODE
* LONGER LEAD TIME MAY APPLY. PLEASE CONTACT YOUR EUREKA REPRESENTATIVE	

FELT FINISH FINI FEUTRE

ABF	AZURE BLUE FELT	BYF	BANANA YELLOW FELT	REF	RED FELT
AWF	ARCTIC WHITE FELT	CHF	CHARCOAL FELT	SGF	SILVER GRAY FELT
BBF	BASIC BLACK FELT	NBF	NAVY BLUE FELT	TGF	TITANIUM GRAY FELT
BOF	BLOOD ORANGE FELT	OBF	OCEAN BLUE FELT	ZFF	ZINFANDEL FELT
BTF	BATTLESHIP GRAY FELT	PGF	PEAR GREEN FELT		
PREMIUM*	PLEASE SPECIFY PREMIUM COLOR CODE – SEE ACOUSTIC MATERIAL COLOR OPTIONS PAGE				
* LONGER LEAD TIME MAY APPLY. PLEASE CONTACT YOUR EUREKA REPRESENTATIVE					

ACCESSORY ACCESSOIRE

ALL ACCESSORIES ARE AVAILABLE FOR ADVANCE SHIPPING	
4903	CONNECTOR BRACKET FOR CLUSTER (ONE PER CONNECTED EDGE) (PLEASE SPECIFY QTY)
39NLAA*	NLIGHT AIR GEN 2 REMOTE POWER PACK
39NLWA*	NLIGHT WIRED REMOTE POWER PACK
* FOR CHICAGO PLENUM INSTALLATION. PLEASE CONTACT YOUR EUREKA REPRESENTATIVE.	

PRODUCT CHARACTERISTICS CARACTÉRISTIQUES DU PRODUIT



SPECIFICATION

HEX AREA ACOUSTIC 4821

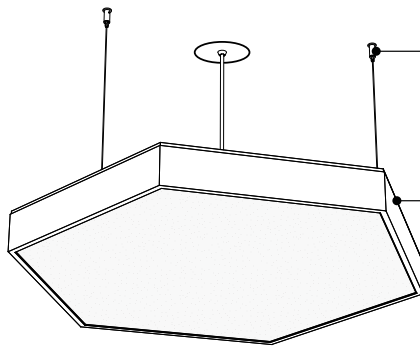

SIMPLIFIED INSTALLATION
Position 3 steel aircraft cables anywhere around a junction box. Easy levelling with adjustable cable grippers

SIMPLE AND CLEAN HOUSING
Precision welded aluminium extrusion. Clean geometry on the outside, structural details on the inside

4821-36

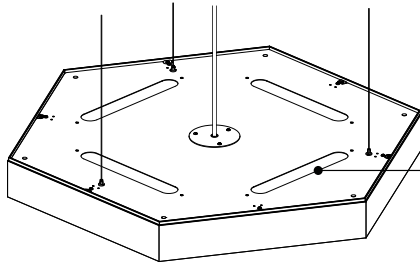

COLORS
Available in 14 standard colors and 16 Premium colors. For all color options, refer to the Acoustic Material Color Options page.

INDIRECT LIGHTING
Dedicated LED indirect lighting modules (48211)
Minimum suspension height of 18" (48211)
Powder-coated steel covers (4821)

CLEANING
A proper and regular cleaning will help extend the lifespan of acoustic products. Remove dust with a vacuum cleaner and light stains with a damp cloth. For greasy and deep stains, a professional dry clean is recommended. Do not use any abrasive, soap, or chemical cleaner.

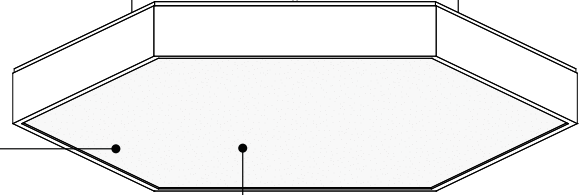

FELT
High density polyester felt panels made from recycled bottles (PET)
The panels are recyclable



NOISE REDUCTION
The center of the product is a large sound absorbing panel that increase acoustic comfort.



Also available in lighting version. See product 4820.

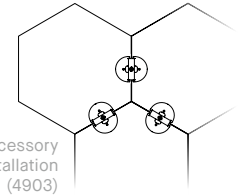

Connector bracket accessory available for cluster installation (4903)

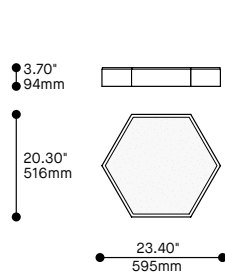

4821-24 / 48211-24

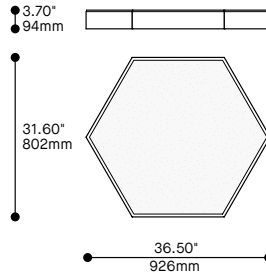

4821-36 / 48211-36

PRODUCT SPECIFICATION

	4821-24	4821-36	48211-24	48211-36
PERFORMANCE			REG / HO	REG / HO
SYSTEM WATTAGE	-	-	20.0W / 40.0W	26.7W / 53.3W
DELIVERED INDIRECT LUMENS (4000K)	-	-	2330LM / 4660LM	3060LM / 6130LM
EFFICACY	-	-	116LM/W	116LM/W

OTHER INFORMATIONS

LUMINAIRE'S WEIGHT	11.6LBS / 5.3KG	22.7LBS / 10.3KG	12.5LBS / 5.7KG	23.6LBS / 10.7KG
L70 (LUMEN MAINTENANCE)	N/A	N/A	> 60 000 HRS	> 60 000 HRS
FELT	HIGH DENSITY 9MM POLYESTER FELT			
ACOUSTIC	ACOUSTIC MATERIAL RATED AT 0.75 NRC			
FIRE RATING	ASTM E84-13 (FELT MATERIAL ONLY)			

WELL & LEED STANDARD REQUIREMENTS

LIGHT QUALITY	R9 > 50 (90 CRI OPTION)	R9 > 50 (90 CRI OPTION)
---------------	-------------------------	-------------------------

EFFICACY MULTIPLIERS

CRI	CCT	FACTOR
80+	4000K	1.00
80+	3500K	0.98
80+	3000K	0.94
80+	2700K	0.91
90+	4000K	0.88
90+	3500K	0.85
90+	3000K	0.81
90+	2700K	0.77

LIGHT DISTRIBUTION

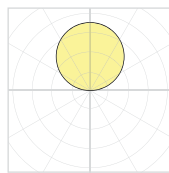

48211-XX



Visit our website for warranty terms and conditions.



TECHNICAL DATA

HEX AREA ACOUSTIQUE 4821

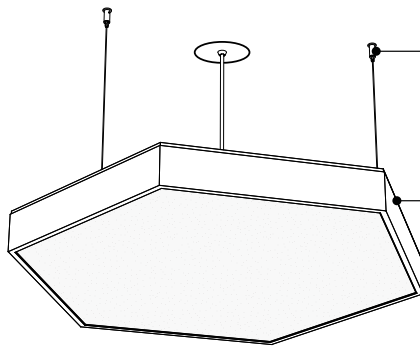

INSTALLATION SIMPLIFIÉE
Situer les 3 câbles de suspension n'importe où autour de la boîte de connection. Mise à niveau et équilibrage rapide avec serre câbles ajustables

BOÎTIER SOBRE
Extrusion d'aluminium soudée avec précision. Lignes nettes et modernes à l'extérieur, détails structuraux cachés à l'intérieur

4821-36

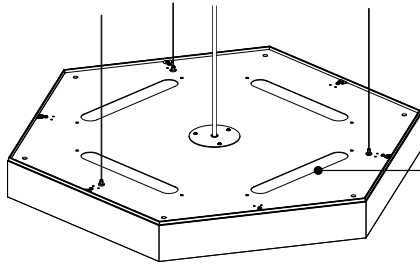

COULEURS
Disponible en 14 couleurs standards et 16 couleurs Premium. Pour la charte de couleurs consultez la fiche d'options de couleurs

ÉCLAIRAGE INDIRECT
Module LED d'éclairage indirect (4821I)
Suspension minimum de 18" (4821I)
Plaquettes en acier peintes (4821)

NETTOYAGE

Un nettoyage approprié et régulier contribuera à prolonger la durée de vie des produits acoustiques. Enlever la poussière avec un aspirateur et les taches légères avec un linge humide. Pour les tâches importantes ou grasses, un nettoyage à sec est recommandé. Ne pas utiliser de produits abrasifs, de savon ou de produits nettoyants chimiques.

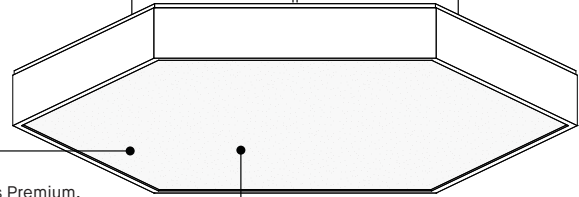

FEUTRE

Panneaux de polyester haute densité faits de bouteilles de plastique recyclées (PET)
Les panneaux sont recyclables



ATTÉNUATION DU BRUIT

Le centre de produit est un grand panneau acoustique qui absorbe le son.



Aussi disponible en version luminaire. Voir le produit 4820.

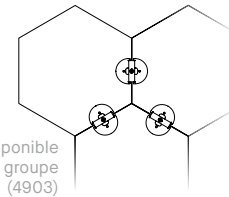

Plaque de support disponible pour l'installation de groupe (4903)

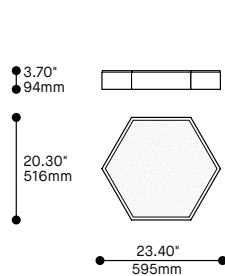

4821-24 / 4821I-24

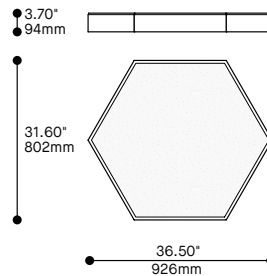

4821-36 / 4821I-36

SPÉCIFICATION PRODUIT

	4821-24	4821-36	4821I-24	4821I-36
PERFORMANCE			REG / HO	REG / HO
PUISSANCE TOTALE	-	-	20.0W / 40.0W	26.7W / 53.3W
LUMENS RÉELS INDIRECT (4000K)	-	-	2330LM / 4660LM	3060LM / 6130LM
EFFICACITÉ			116LM/W	116LM/W
AUTRES INFORMATIONS		X		
POIDS DU LUMINAIRE	11.6LBS / 5.3KG	22.7LBS / 10.3KG	12.5LBS / 5.7KG	23.6LBS / 10.7KG
L70 (MAINTENANCE DE LA LUMIÈRE) FEUTRE ACOUSTIC	N/A	N/A	> 60 000 H	> 60 000 H
RÉSISTANCE AU FEU		FEUTRE DE POLYESTER HAUTE DENSITÉ 9MM MATÉRIEL ACOUSTIQUE GRADÉ À 0.75 NRC ASTM E84-13 (MATÉRIEL FEUTRE SEULEMENT)		
CRITÈRES DE CERTIFICATION WELL & LEED				
QUALITÉ DE LA LUMIÈRE			R9 > 50 (OPTION 90 IRC)	R9 > 50 (OPTION 90 IRC)

FACTEUR D'EFFICACITÉ

IRC	CCT	FACTEUR
80+	4000K	1.00
80+	3500K	0.98
80+	3000K	0.94
80+	2700K	0.91
90+	4000K	0.88
90+	3500K	0.85
90+	3000K	0.81
90+	2700K	0.77

DISTRIBUTION LUMINEUSE

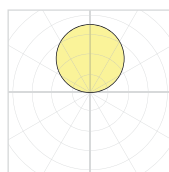

4821I-XX



Visitez notre site Web pour les termes et conditions.