

MILL 047" SUSPENDED

PROJECT PROJÉT
SPEC TYPE
NOTES

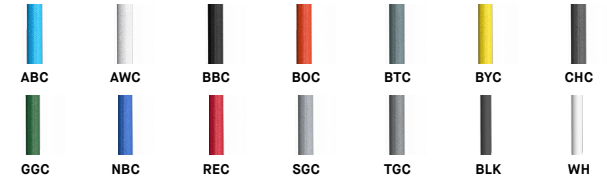

POWER CORD FINISH FINI CÂBLE D'ALIMENTATION



SHADE FINISH FINI ABAT-JOUR



ADDITIONAL PREMIUM COLORS AVAILABLE – SEE ACOUSTIC MATERIAL COLOR OPTIONS PAGE

MOUNTING OPTIONS OPTIONS DE MONTAGE

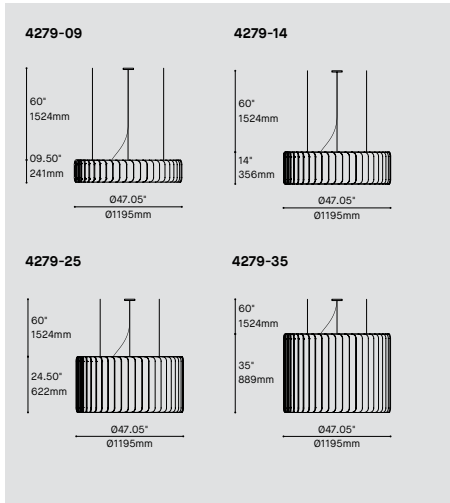
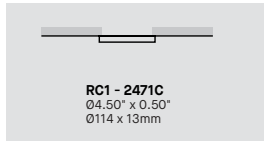

ORDERING SPECIFICATION SPÉCIFICATION DE COMMANDE

CODE

MODEL MODÈLE			
4279D-09	MILL 9.5" (DIRECT)		
4279D-14	MILL 14" (DIRECT)		
4279D-25	MILL 25" (DIRECT)		
4279D-35	MILL 35" (DIRECT)		
4279DI-09	MILL 9.5" (DIRECT + INDIRECT)		
4279DI-14	MILL 14" (DIRECT + INDIRECT)		
4279DI-25	MILL 25" (DIRECT + INDIRECT)		
4279DI-35	MILL 35" (DIRECT + INDIRECT)		
LIGHT SOURCE SOURCE LUMINEUSE			
4279D-XX			
LED.LO	LOW OUTPUT		
LED	REGULAR OUTPUT		
LED.HO	HIGH OUTPUT		
4279DI-XX			
LED.LO.REG	LOW OUTPUT DIRECT, REGULAR OUTPUT INDIRECT		
LED.LO.HO	LOW OUTPUT DIRECT, HIGH OUTPUT INDIRECT		
LED.REG.REG	REGULAR OUTPUT DIRECT, REGULAR OUTPUT INDIRECT		
LED.REG.HO	REGULAR OUTPUT DIRECT, HIGH OUTPUT INDIRECT		
LED.HO.REG	HIGH OUTPUT DIRECT, REGULAR OUTPUT INDIRECT		
LED.HO.HO	HIGH OUTPUT DIRECT, HIGH OUTPUT INDIRECT		
COLOR TEMPERATURE TEMPÉRATURE DE COULEUR			
27*	2700K		
30	3000K		
35	3500K		
40	4000K		
* LONGER LEAD TIME MAY APPLY, PLEASE CONTACT YOUR EUREKA REPRESENTATIVE			
COLOR RENDERING INDEX (CRI) INDICE DE RENDU DE COULEUR (IRC)		90	
90	90+ CRI		
VOLTAGE VOLTAGE			
120V	120 VOLT		
277V	277 VOLT		
CONTROL OPTION OPTION DE CONTRÔLE			
DV	0-10V DIMMING (120V-277V)		
NLTAIR2*	NLIGHT AIR CONTROL GEN 2		
NLIGHT*	NLIGHT WIRED CONTROL		
* NLIGHT INTEGRATION REQUIRES A REMOTE POWER PACK (39NLAB FOR NLTAIR2 OR 39NLWB FOR NLIGHT).			
* DUAL DIMMING NOT AVAILABLE WITH NLIGHT OPTIONS			
* FOR EMERGENCY BATTERY WITH NLIGHT OPTIONS, PLEASE CONTACT YOUR EUREKA REPRESENTATIVE REFER TO NLIGHT GUIDE AND INSTALLATION SHEET FOR ALL REQUIREMENTS.			
EMERGENCY BATTERY BATTERIE D'URGENCE			
APPLIES TO DOWNLIGHT PORTION ONLY. EM DRIVER BOX INCLUDED, INSTALLED REMOTELY. SEE EM GUIDE FOR DETAILS. CLEAR POWER CABLE ONLY AVAILABLE FOR EMB OPTION.			
EMB*	EMERGENCY BATTERY FOR REMOTE BOX		
* 3981EA ACCESSORY IS REQUIRED			
CABLE CÂBLE		AC	
AC	AIRCRAFT MOUNTING & POWER CORD, FIELD ADJUSTABLE		
CABLE LENGTH LONGUEUR DE CÂBLE			
60	60" AIRCRAFT CABLE (STD LENGTH)		
**	CUSTOM AIRCRAFT CABLE LENGTH (PLEASE SPECIFY)		
FOR OVERALL LENGTH, PLEASE CONTACT YOUR EUREKA REPRESENTATIVE			
MOUNTING MONTAGE		RC1	
RC1	ROUND CANOPY / PAVILLON ROND SCREWLESS CANOPY 04.50" X 0.5" (2471C)		
MOUNTING CABLE OPTION OPTION DE MONTAGE DE CÂBLE		RCC	
RCC	CENTERED CANOPY - STRAIGHT AIRCRAFT CABLES		
CANOPY FINISH FINI PAVILLON			
BLKE	BLACK FINE TEXTURE		
WHE	WHITE FINE TEXTURE		
POWER CORD FINISH FINI CÂBLE D'ALIMENTATION			
BLK	BLACK VINYL	BOC* BLOOD ORANGE	NBC* NAVY BLUE
WH	WHITE VINYL	BTC* BATTLESHIP GRAY	RGC* RED
ABC* AZURE BLUE	BYC* BANANA YELLOW	SGC* SILVER GRAY	TGC* TITANIUM GRAY
AWC* ARCTIC WHITE	CHC* CHARCOAL	TGC* TITANIUM GRAY	CLR** CLEAR
BBC* BASIC BLACK	GGC* GRASS GREEN		
* TEXTILE BRAIDED CORD, ADDITIONAL COST AND LONGER LEAD TIME MAY APPLY, PLEASE CONTACT YOUR EUREKA REPRESENTATIVE			
** ONLY OPTION AVAILABLE WITH EMERGENCY OPTION.			
SHADE FINISH FINI ABAT-JOUR			
ABF AZURE BLUE FELT	BYF BANANA YELLOW FELT	REF RED FELT	
AWF ARCTIC WHITE FELT	CHF CHARCOAL FELT	SGF SILVER GRAY FELT	
BBF BASIC BLACK FELT	NBF NAVY BLUE FELT	TGF TITANIUM GRAY FELT	
BOF BLOOD ORANGE FELT	OBF OCEAN BLUE FELT	ZFF FELT ZINFANDEL	
BTF BATTLESHIP GRAY FELT	PGF PEAR GREEN FELT		
PREMIUM*	PLEASE SPECIFY PREMIUM COLOR CODE – SEE ACOUSTIC MATERIAL COLOR OPTIONS PAGE		
* LONGER LEAD TIME MAY APPLY, PLEASE CONTACT YOUR EUREKA REPRESENTATIVE			



SPECIFICATION

DIFFUSER FINISH FINI DIFFUSEUR		WH
WH	WHITE	
ACCESSORY ACCESSOIRE		
ALL ACCESSORIES ARE AVAILABLE FOR ADVANCE SHIPPING		
39NLAA*	NLIGHT AIR GEN 2 REMOTE POWER PACK	
39NLWA*	NLIGHT WIRED REMOTE POWER PACK	
	* FOR CHICAGO PLENUM INSTALLATION, PLEASE CONTACT YOUR EUREKA REPRESENTATIVE .	
EMERGENCY BATTERY ACCESSORY ACCESSOIRE BATTERIE D'URGENCE		
3981EA	ELECTRICAL BOX FOR EMB EMERGENCY BATTERY	

PRODUCT CHARACTERISTICS CARACTÉRISTIQUES DU PRODUIT



DESIGN:	MILL is a high-performance fixture with a simple shape punctuated by its repeated acoustic felt panels. With its four different diameters, four different lengths and two mounting options, this fixture is versatile to suite various needs and spaces.
INSTALLATION:	Easy to install, adjust and level single aircraft cable mounting, with clip-on acoustic panels. Also available as surface mount.
LIGHT SOURCE:	This pendant offers powerful and evenly diffused lighting with a COB light source. Phase or 0-10V dimming offered. MILL is also offered with an optional indirect light option on a secondary circuit allowing independent control.
SHADE:	The custom CNC-cut rigid felt acoustic panels are available in multiple colors. Composed mainly of recycled polyethylene (PET) bottles which make them recyclable and odorless.

MILL 047" SUSPENDED

PROJECT PROJCT
SPEC TYPE
NOTES



POWER CORD FINISH FINI CABLE D'ALIMENTATION

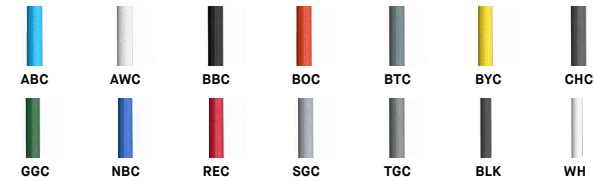

SHADE FINISH FINI ABAT-JOUR



ADDITIONAL PREMIUM COLORS AVAILABLE – SEE ACOUSTIC MATERIAL COLOR OPTIONS PAGE

MOUNTING OPTIONS OPTIONS DE MONTAGE

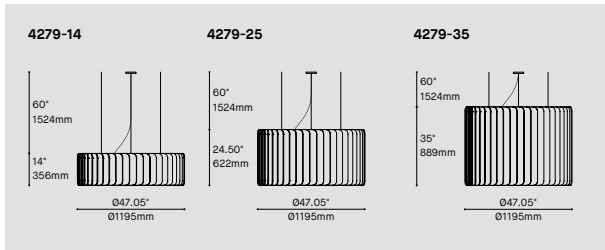
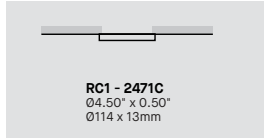

ORDERING SPECIFICATION SPÉCIFICATION DE COMMANDE

CODE

MODEL MODÈLE

- 4279D-14 MILL 14" (DIRECT)
- 4279D-25 MILL 25" (DIRECT)
- 4279D-35 MILL 35" (DIRECT)
- 4279DI-14 MILL 14" (DIRECT + INDIRECT)
- 4279DI-25 MILL 25" (DIRECT + INDIRECT)
- 4279DI-35 MILL 35" (DIRECT + INDIRECT)

LIGHT SOURCE SOURCE LUMINEUSE

- 4279D-XX
- LED.LO LOW OUTPUT
- LED REGULAR OUTPUT
- LED.HO HIGH OUTPUT

4279DI-XX

- LED.LO.REG LOW OUTPUT DIRECT, REGULAR OUTPUT INDIRECT
- LED.LO.HO LOW OUTPUT DIRECT, HIGH OUTPUT INDIRECT
- LED.REG.REG REGULAR OUTPUT DIRECT, REGULAR OUTPUT INDIRECT
- LED.REG.HO REGULAR OUTPUT DIRECT, HIGH OUTPUT INDIRECT
- LED.HO.REG HIGH OUTPUT DIRECT, REGULAR OUTPUT INDIRECT
- LED.HO.HO HIGH OUTPUT DIRECT, HIGH OUTPUT INDIRECT

COLOR TEMPERATURE TEMPÉRATURE DE COULEUR

- 27* 2700K
- 30 3000K
- 35 3500K
- 40 4000K

* LONGER LEAD TIME MAY APPLY, PLEASE CONTACT YOUR EUREKA REPRESENTATIVE

COLOR RENDERING INDEX (CRI) INDICE DE RENDU DE COULEUR (IRC)

- 90 90+ CRI

90

VOLTAGE VOLTAGE

- 120V 120 VOLT
- 277V 277 VOLT

CONTROL OPTION OPTION DE CONTRÔLE

- DV 0-10V DIMMING (120V-277V)
- NLTAIR2* NLIGHT AIR CONTROL GEN 2
- NLIGHT* NLIGHT WIRED CONTROL

* NLIGHT INTEGRATION REQUIRES A REMOTE POWER PACK (39NLAB FOR NLTAIR2 OR 39NLWB FOR NLIGHT).
* DUAL DIMMING NOT AVAILABLE WITH NLIGHT OPTIONS
* FOR EMERGENCY BATTERY WITH NLIGHT OPTIONS, PLEASE CONTACT YOUR EUREKA REPRESENTATIVE
REFER TO NLIGHT GUIDE AND INSTALLATION SHEET FOR ALL REQUIREMENTS.

EMERGENCY BATTERY BATTERIE D'URGENCE

APPLIES TO DOWNLIGHT PORTION ONLY. EM DRIVER BOX INCLUDED, INSTALLED REMOTELY. SEE EM GUIDE FOR DETAILS.
CLEAR POWER CABLE ONLY AVAILABLE FOR EMB OPTION.

- EMB* EMERGENCY BATTERY FOR REMOTE BOX
- * 3981EA ACCESSORY IS REQUIRED

CABLE CÂBLE

- AC AIRCRAFT MOUNTING & POWER CORD, FIELD ADJUSTABLE

AC

CABLE LENGTH LONGUEUR DE CÂBLE

- 60 60" AIRCRAFT CABLE (STD LENGTH)
- ** CUSTOM AIRCRAFT CABLE LENGTH (PLEASE SPECIFY)
FOR OVERALL LENGTH, PLEASE CONTACT YOUR EUREKA REPRESENTATIVE

MOUNTING MONTAGE

- ROUND CANOPY / PAVILLON ROND
- RC1 SCREWLESS CANOPY 04.50" X 0.5" (2471C)

RC1

MOUNTING CABLE OPTION OPTION DE MONTAGE DE CÂBLE

- RCC CENTERED CANOPY - STRAIGHT AIRCRAFT CABLES

RCC

CANOPY FINISH FINI PAVILLON

- BLKE BLACK FINE TEXTURE
- WHE WHITE FINE TEXTURE

POWER CORD FINISH FINI CABLE D'ALIMENTATION

- BLK BLACK VINYL
- WH WHITE VINYL
- ABC* AZURE BLUE
- AWC* ARCTIC WHITE
- BBC* BASIC BLACK
- BOC* BLOOD ORANGE
- BTC* BATTLESHIP GRAY
- BYC* BANANA YELLOW
- CHC* CHARCOAL
- GGC* GRASS GREEN
- NBC* NAVY BLUE
- REC* RED
- SGC* SILVER GRAY
- TGC* TITANIUM GRAY
- CLR** CLEAR

* TEXTILE BRAIDED CORD, ADDITIONAL COST AND LONGER LEAD TIME MAY APPLY, PLEASE CONTACT YOUR EUREKA REPRESENTATIVE
** ONLY OPTION AVAILABLE WITH EMERGENCY OPTION.

SHADE FINISH FINI ABAT-JOUR

- ABF AZURE BLUE FELT
- AWF ARCTIC WHITE FELT
- BBF BASIC BLACK FELT
- BOF BLOOD ORANGE FELT
- BTF BATTLESHIP GRAY FELT
- BYF BANANA YELLOW FELT
- CHF CHARCOAL FELT
- NBF NAVY BLUE FELT
- OBF OCEAN BLUE FELT
- PGF PEAR GREEN FELT
- REF RED FELT
- SGF SILVER GRAY FELT
- TGF TITANIUM GRAY FELT
- ZFF FELT ZINFANDEL FELT

PREMIUM* PLEASE SPECIFY PREMIUM COLOR CODE – SEE ACOUSTIC MATERIAL COLOR OPTIONS PAGE
* LONGER LEAD TIME MAY APPLY, PLEASE CONTACT YOUR EUREKA REPRESENTATIVE

DIFFUSER FINISH FINI DIFFUSEUR		WH
WH	WHITE	
ACCESSORY ACCESSOIRE		
ALL ACCESSORIES ARE AVAILABLE FOR ADVANCE SHIPPING		
39NLAA*	NLIGHT AIR GEN 2 REMOTE POWER PACK	
39NLWA*	NLIGHT WIRED REMOTE POWER PACK	
	* FOR CHICAGO PLENUM INSTALLATION, PLEASE CONTACT YOUR EUREKA REPRESENTATIVE .	
EMERGENCY BATTERY ACCESSORY ACCESSOIRE BATTERIE D'URGENCE		
3981EA	ELECTRICAL BOX FOR EMB EMERGENCY BATTERY	

PRODUCT CHARACTERISTICS CARACTÉRISTIQUES DU PRODUIT



- DESIGN:** MILL is a high-performance fixture with a simple shape punctuated by its repeated acoustic felt panels. With its three different diameters, three different lengths and two mounting options, this fixture is versatile to suite various needs and spaces.
- INSTALLATION:** Easy to install, adjust and level single aircraft cable mounting, with clip-on acoustic panels. Also available as surface mount.
- LIGHT SOURCE:** This pendant offers powerful and evenly diffused lighting with a COB light source. Phase or 0-10V dimming offered. MILL is also offered with an optional indirect light option on a secondary circuit allowing independent control.
- SHADE:** The custom CNC-cut rigid felt acoustic panels are available in multiple colors. Composed mainly of recycled polyethylene (PET) bottles which make them recyclable and odorless.

MILL 047" SUSPENDED

QUICKSHIP

PROJECT PROJET

SPEC TYPE

NOTES



SHADE FINISH FINI ABAT-JOUR



MOUNTING OPTIONS OPTIONS DE MONTAGE

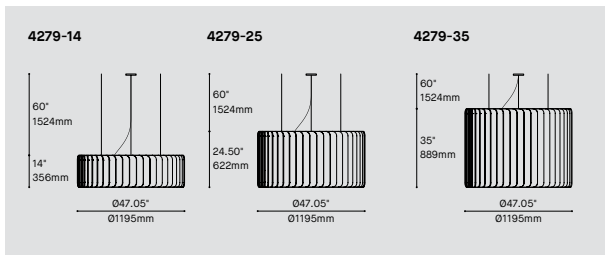
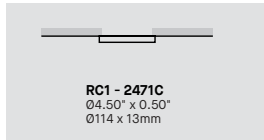

ORDERING SPECIFICATION SPÉCIFICATION DE COMMANDE

CODE

QUICKSHIP

QS10 QUICKSHIP 10 DAYS - MAXIMUM 5 UNITS QUICKSHIP 10 JOURS - MAXIMUM 5 UNITÉS

MODEL MODÈLE

4279D-14 MILL 14" (DIRECT)
 4279D-25 MILL 25" (DIRECT)
 4279D-35 MILL 35" (DIRECT)
 4279DI-14 MILL 14" (DIRECT + INDIRECT)
 4279DI-25 MILL 25" (DIRECT + INDIRECT)
 4279DI-35 MILL 35" (DIRECT + INDIRECT)

LIGHT SOURCE SOURCE LUMINEUSE

4279D-XX
 LED.LO LOW OUTPUT
 LED REGULAR OUTPUT
 LED.HO HIGH OUTPUT

4279DI-XX

LED.LO.REG LOW OUTPUT DIRECT, REGULAR OUTPUT INDIRECT
 LED.LO.HO LOW OUTPUT DIRECT, HIGH OUTPUT INDIRECT
 LED.REG.REG REGULAR OUTPUT DIRECT, REGULAR OUTPUT INDIRECT
 LED.REG.HO REGULAR OUTPUT DIRECT, HIGH OUTPUT INDIRECT
 LED.HO.REG HIGH OUTPUT DIRECT, REGULAR OUTPUT INDIRECT
 LED.HO.HO HIGH OUTPUT DIRECT, HIGH OUTPUT INDIRECT

COLOR TEMPERATURE TEMPÉRATURE DE COULEUR

30 3000K
 35 3500K

COLOR RENDERING INDEX (CRI) INDICE DE RENDU DE COULEUR (IRC)

90 90+ CRI

VOLTAGE VOLTAGE

120V 120 VOLT
 277V 277 VOLT

CONTROL OPTION OPTION DE CONTRÔLE

DV 0-10V DIMMING (120V-277V)

CABLE CÂBLE

AC AIRCRAFT MOUNTING & POWER CORD, FIELD ADJUSTABLE

CABLE LENGTH LONGUEUR DE CÂBLE

60 60" AIRCRAFT CABLE (STD LENGTH)
 ** CUSTOM AIRCRAFT CABLE LENGTH (PLEASE SPECIFY)
 FOR OVERALL LENGTH, PLEASE CONTACT YOUR EUREKA REPRESENTATIVE

MOUNTING MONTAGE

RC1 ROUND CANOPY / PAVILLON ROND
 SCREWLESS CANOPY 04.50" X 0.5" (2471C)

MOUNTING CABLE OPTION OPTION DE MONTAGE DE CÂBLE

RCC CENTERED CANOPY - STRAIGHT AIRCRAFT CABLES

CANOPY FINISH FINI PAVILLON

BLKE BLACK FINE TEXTURE
 WHE WHITE FINE TEXTURE

POWER CORD FINISH FINI CÂBLE D'ALIMENTATION

BLK BLACK POWER CORD
 WH WHITE POWER CORD

SHADE FINISH FINI ABAT-JOUR

ABF AZURE BLUE FELT BYF BANANA YELLOW FELT REF RED FELT
 AWF ARCTIC WHITE FELT CHF CHARCOAL FELT SGF SILVER GRAY FELT
 BBF BASIC BLACK FELT NBF NAVY BLUE FELT TGF TITANIUM GRAY FELT
 BOF BLOOD ORANGE FELT OBF OCEAN BLUE FELT ZFF ZINFANDEL FELT
 BTF BATTLESHIP GRAY FELT PGF PEAR GREEN FELT

DIFFUSER FINISH FINI DIFFUSEUR

WH WHITE

PRODUCT CHARACTERISTICS CARACTÉRISTIQUES DU PRODUIT



Acoustic Material Color Options for Mill



Standard colors



ABF
Azure Blue



AWF
Arctic White



BBF
Basic Black



BOF
Blood Orange

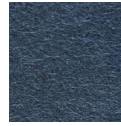

BTF
Battleship Gray



BYF
Banana Yellow



CHF
Charcoal

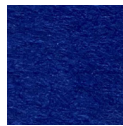

NBF
Navy Blue

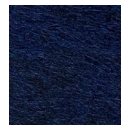

OBF
Ocean Blue

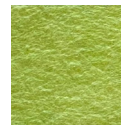

PGF
Pear Green



REF
Red



SGF
Silver Gray



TGF
Titanium Gray

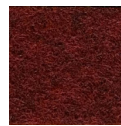

ZFF
Zinfandel

Premium colors



BGF
Bubble Gum

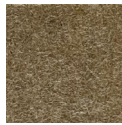

BKF
Bark Brown

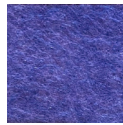

DBF
Denim Blue



DTF
Deep Teal Green



DYF
Daisy Yellow



GGF
Grass Green



LBF
Light Beige

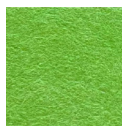

LGF
Lime Green

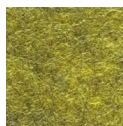

MGF
Moss Green

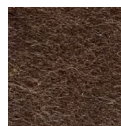

OAF
Oak Brown

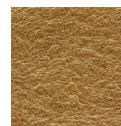

PBF
Peanut Brown



PNF
Pinot Noir

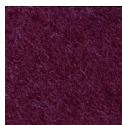

PPF
Plum Purple



SBF
Sky Blue



TOF
Tangerine Orange



TPF
Tulip Purple

- Premium colors carry extended lead times. Additional fees may apply for expedited lead times. Please consult factory.
- Due to the dye process, colors may vary slightly from batch to batch.

Cable Color Options for Mill

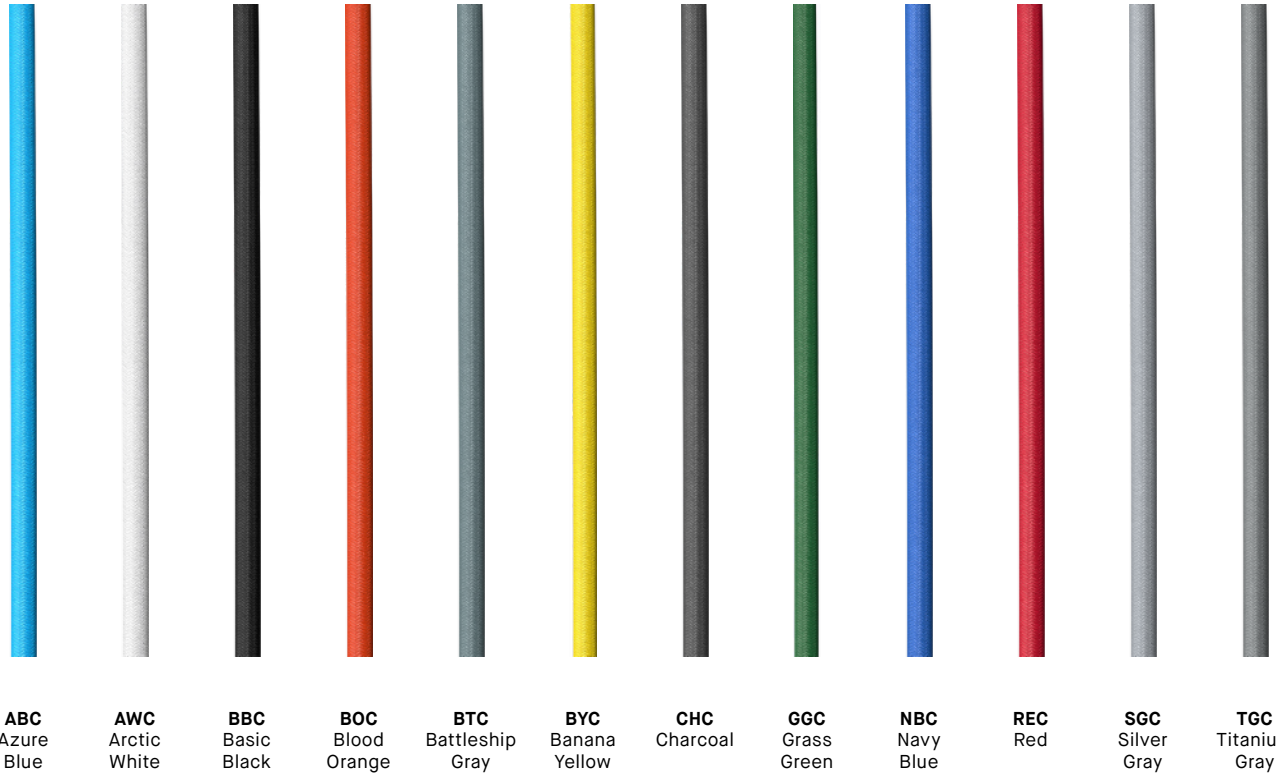

The cable has a $\varnothing 0.265$ in (direct) or $\varnothing 0.375$ in (direct+indirect) and is covered with a decorative braided sleeve.

- Longer lead time may apply.
- Colors shown for visual reference only.
- Due to the dye process, colors may vary slightly from batch to batch.
- Consult your sales representative or factory to get a sample.
- Not available with Emergency Battery option.

MILL 036" / 047"

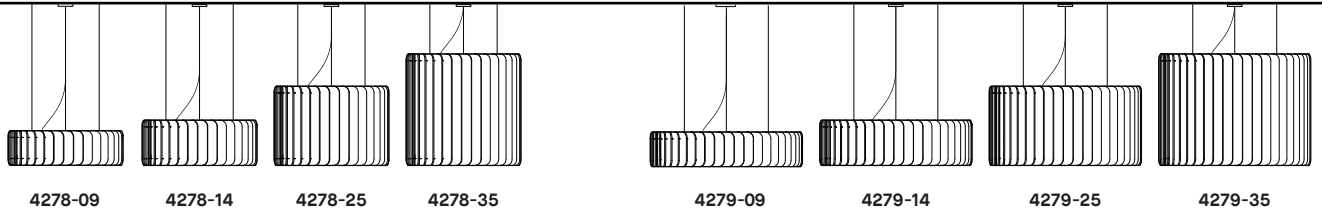

DEUX OPTIONS DE MONTAGE

Le luminaire peut être suspendu ou monté en surface selon les besoins de l'espace.

POSITION CANOPY

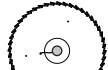
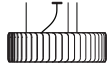

RCC

PANNEAUX RECYCLÉS

Panneaux composés de fibres de polyester (PET) avec 42% de matière recyclées. 100% recyclable, non-toxique, non-allergène et non-irritable. Faible teneur en COV et résistance au feu.

SOURCES POLYVALENTES

Source LOW, REG et HO permettent une grande variété d'applications.



ATTÉNUATION DU BRUIT

La superposition des panneaux verticaux augmente la surface effective du matériel insonorisant, optimisant les performances acoustiques du luminaire. Les panneaux sont disponibles en 30 couleurs. Pour toutes options de couleurs, consulter la page d'options de couleurs de matérielle acoustique.

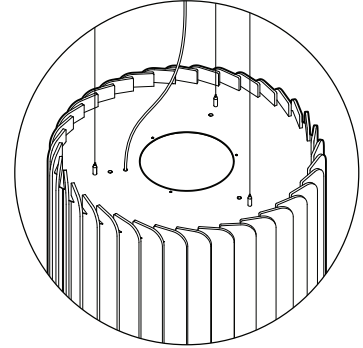
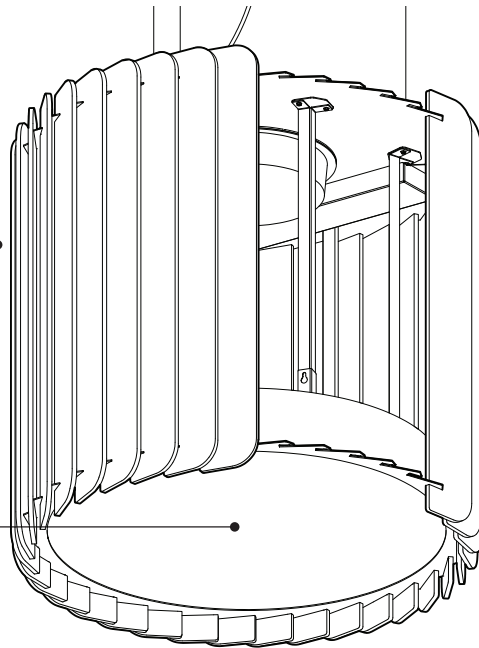

427X-DI

SOURCE INDIRECTE PUISSANTE

La version suspension offre en option une seconde source lumineuse pour offrir un éclairage indirect performant. Les deux sources peuvent se régler séparément. Nous recommandons une suspension minimum de 22" pour avoir une lumière indirecte diffuse.

NETTOYAGE

Un nettoyage approprié et régulier contribuera à prolonger la durée de vie des produits acoustiques. Un nettoyage périodique peut être fait avec un aspirateur ou en essuyant avec un chiffon humide. Ne pas utiliser de produits abrasifs, de savon ou de produits nettoyants chimiques.

SPÉCIFICATION PRODUIT

036" DIRECT

047" DIRECT

036"/047" INDIRECT

PERFORMANCE	LO	REG	HO	LO	REG	HO	REG	HO
PUISSANCE TOTALE	56W	82W	121W	128W	185W	276W	19W	29W
LUMENS RÉELS (4000K)	3955 LM	5390 LM	7424 LM	8784 LM	11971 LM	16489 LM	1408 LM	2051 LM
AUTRES INFORMATION								
POIDS	40LBS / 18KG			60LBS / 27KG				
L70 (MAINTENANCE DE LA LUMIÈRE)	60,000			54,700				
CRITÈRES DE CERTIFICATION WELL								
MAX. LUMINANCE 450-900 NADIR	1 150CD/M ² (EN HO)							
QUALITÉ DE LA LUMIÈRE	R9 > 50 (OPTION 90 IRC)							

FACTEUR D'EFFICACITÉ

IRC	CCT	FACTEUR
90+	4000K	1.00
90+	3500K	0.98
90+	3000K	0.94
90+	2700K	0.91

DISTRIBUTION LUMINEUSE

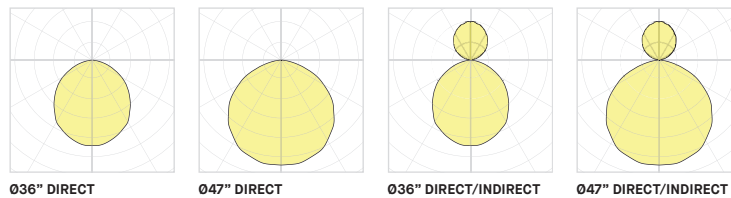

Visitez notre site Web pour les termes et conditions.



DONNÉES TECHNIQUES