

# SEGMENT 74510

PROJECT PROJCT
SPEC TYPE
NOTES

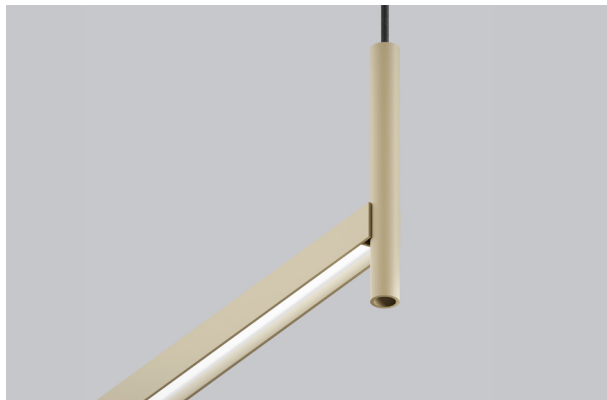

## MOUNTING OPTIONS OPTIONS DE MONTAGE

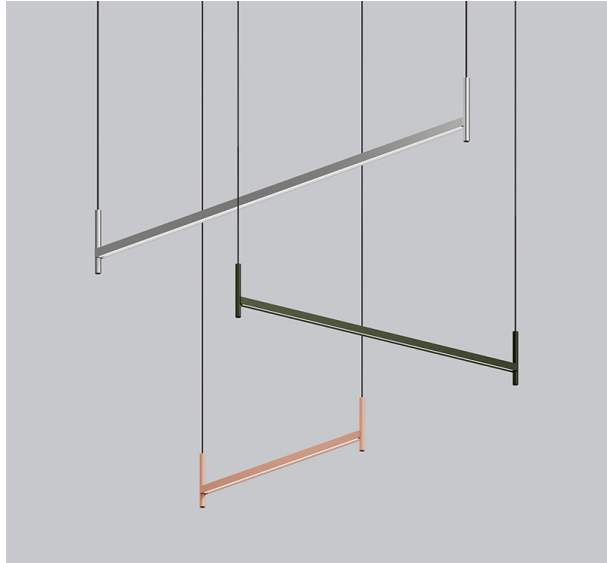
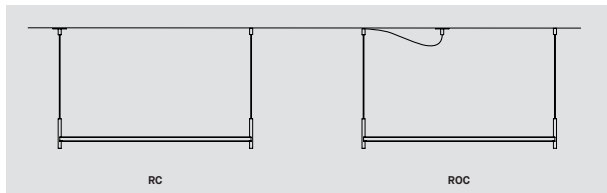
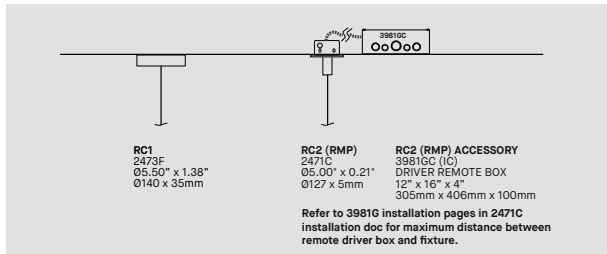

ORDERING SPECIFICATION SPÉCIFICATION DE COMMANDE		CODE	
<b>MODEL MODÈLE</b>			
<b>74510D</b>	SEGMENT - DIRECT ILLUMINATION		
<b>74510DI</b>	SEGMENT - DIRECT & INDIRECT ILLUMINATION		
<b>CONFIGURATION</b>			
<b>48</b>	48"		
<b>72</b>	72"		
<b>96</b>	96"		
<b>LIGHT SOURCE SOURCE LUMINEUSE</b>			
<b>LED</b>	REGULAR OUTPUT		
<b>LED.HO*</b>	HIGH OUTPUT		
	* NOT AVAILABLE FOR 74510DI-72 AND 74510DI-96 WITH THE RC1 CANOPY		
<b>COLOR TEMPERATURE TEMPÉRATURE DE COULEUR</b>			
<b>27</b>	2700K		
<b>30</b>	3000K		
<b>35</b>	3500K		
<b>40*</b>	4000K		
	* LONGER LEAD TIME MAY APPLY, PLEASE CONTACT YOUR EUREKA REPRESENTATIVE		
<b>COLOR RENDERING INDEX (CRI) INDICE DE RENDU DE COULEUR (IRC)</b>		<b>90</b>	
<b>90</b>	90+ CRI		
<b>VOLTAGE VOLTAGE</b>			
<b>120V</b>	120 VOLT		
<b>277V</b>	277 VOLT		
<b>CONTROL OPTION OPTION DE CONTRÔLE</b>			
<b>DP*</b>	PHASE DIMMING (120V ONLY)		
<b>DV</b>	0-10V DIMMING (120V-277V)		
<b>NLTAIR2**</b>	NLIGHT AIR CONTROL GEN 2		
<b>NLIGHT**</b>	NLIGHT WIRED CONTROL		
	* CONSULT CANOPY COMPATIBILITY CHART AT THE END OF DOC. FOR AVAILABILITY		
	** NLIGHT INTEGRATION REQUIRES THE USAGE OF A REMOTE POWER PACK ACC. (39NLWA OR 39NLAA)		
	** ONLY NLIGHT WIRED IS COMPATIBLE WITH RC2		
	LONGER LEAD TIME MAY APPLY, PLEASE CONTACT YOUR EUREKA REPRESENTATIVE		
	REFER TO NLIGHT GUIDE AND INSTALLATION SHEET FOR ALL REQUIREMENTS		
<b>EMERGENCY BATTERY BATTERIE D'URGENCE</b>			
<b>EMB*</b>	EMERGENCY BATTERY FOR REMOTE BOX		
	* 3981E ACCESSORY IS REQUIRED FOR THIS OPTION		
<b>CABLE CÂBLE</b>		<b>C</b>	
<b>C</b>	POWER CABLE, FIELD ADJUSTABLE		
<b>CABLE LENGTH LONGUEUR DE CÂBLE</b>			
<b>60</b>	60" CABLE (STD LENGTH)		
<b>**</b>	CUSTOM CABLE LENGTH (PLEASE SPECIFY)		
	FOR OVERALL LENGTH PLEASE CONTACT YOUR EUREKA REPRESENTATIVE.		
<b>MOUNTING MONTAGE</b>			
	CONSULT CANOPY AVAILABILITY CHART AT THE END OF DOCUMENT FOR COMPATIBILITY		
<b>RC1*</b>	SCREWLESS CANOPY 05.50" X 1.35" (2473F)		
<b>RC2**</b>	REMOTE DRIVER OPTION SCREWLESS CANOPY 05.00" X 0.21" (2471C)		
	* NOT AVAILABLE FOR 74510DI-72-HO AND 74510DI-96-HO.		
	** REQUIRES ACCESSORY 3981GC.		
<b>MOUNTING OPTION OPTIONS DE MONTAGE</b>			
<b>RC</b>	CANOPY ALIGNED WITH END OF LUMINAIRE (1 ANCHOR)		
<b>ROC</b>	CANOPY OFFSET WITH END OF LUMINAIRE (2 ANCHORS)		
<b>CANOPY AND ANCHORS FINISH FINI PAVILLON ET ANCRAGE(S)</b>			
<b>BLKE</b>	BLACK		
<b>WHE</b>	WHITE		
<b>MATCH*</b>	COLOR MATCH WITH LUMINAIRE		
	* LONGER LEAD TIME MAY APPLY, PLEASE CONTACT YOUR EUREKA REPRESENTATIVE		
<b>POWER CABLE FINISH FINI CÂBLE ALIMENTATION</b>			
<b>BBC</b>	BLACK BRAIDED CABLE		
<b>AWC</b>	ARTIC WHITE BRAIDED CABLE		
<b>FIXTURE FINISH FINI LUMINAIRE</b>			
<b>BLKE</b>	BLACK	<b>CBE*</b> CHOCOLATE BROWN	<b>NBE*</b> NAVY BLUE
<b>WHE</b>	WHITE	<b>CPE*</b> CLAY PINK	<b>SBE*</b> SAND BEIGE
<b>CHM*</b>	CHAMPAGNE METALLIC	<b>DBE*</b> DYNAMIC BLUE	<b>SGE*</b> SAGE GREY
<b>SIM*</b>	SILVER METALLIC	<b>GGE*</b> GRASS GREEN	<b>STE*</b> SUMMER TEAL
<b>AYE*</b>	APRICOT YELLOW	<b>HGE*</b> HUNTER GREEN	
<b>BRE*</b>	BRICK RED	<b>LNE*</b> LUNAR GREY	
<b>RAL**</b>	PLEASE SPECIFY RAL CODE		
	ALL FINISHES ARE FINE TEXTURED WITH THE EXCEPTION OF CHM, SIM		
	* LONGER LEAD TIME MAY APPLY, PLEASE CONTACT YOUR EUREKA REPRESENTATIVE		
	** SPECIFY 4 DIGIT RAL CLASSIC CODE. LONGER LEAD TIME MAY APPLY, PLEASE CONTACT YOUR EUREKA REPRESENTATIVE		

**DIFFUSER FINISH** FINI DIFFUSEUR

**FRO** FROST  
**PRI** PRISMATIC

**ACCESSORY** ACCESSOIRE

ALL ACCESSORIES ARE AVAILABLE FOR ADVANCE SHIPPING  
CONSULT CANOPY AVAILABILITY CHART AT THE END OF DOCUMENT FOR COMPATIBILITY

**3981GC** 1 DRIVER BOX FOR REMOTE INSTALLATION - 4" X 12" X 16"  
**39NLAA** NLIGHT AIR GEN 2 REMOTE CONTROLLER  
**39NLWA** NLIGHT WIRED REMOTE CONTROLLER

**ACCESSORY EMERGENCY BATTERY** ACCESSOIRE BATTERIE D'URGENCE

**3981EA** ELECTRICAL BOX FOR EMB EMERGENCY BATTERY

48" NOMINAL

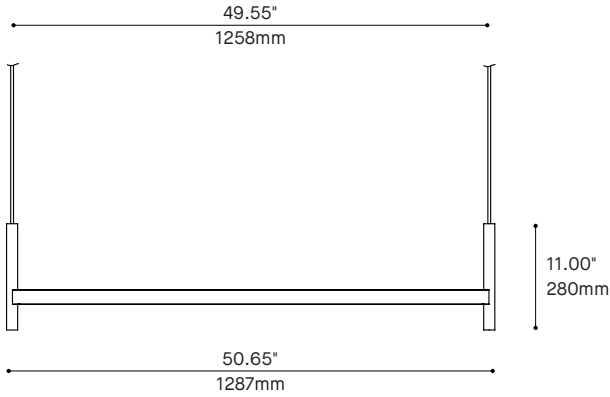

72" NOMINAL

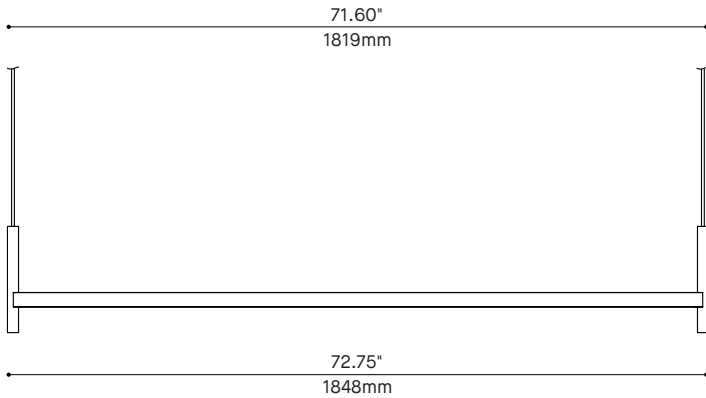

96" NOMINAL

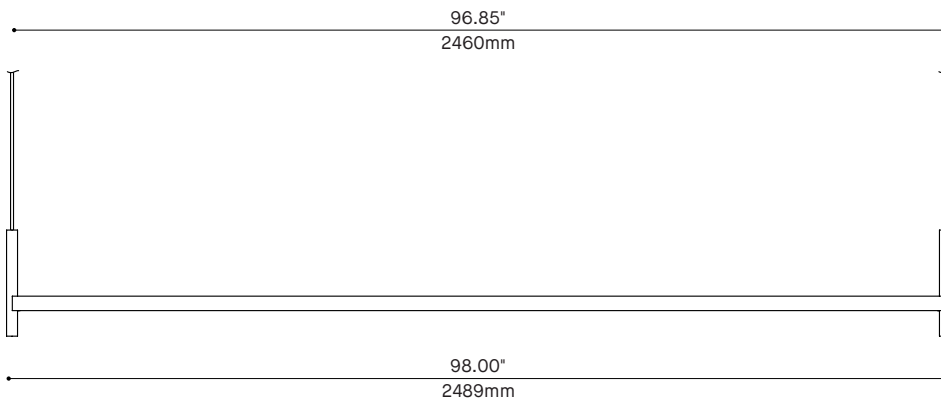

# JUNCTION 74710 - FINISH OPTIONS / OPTIONS DE FINIS

## Standard



**BLKE**  
Black Textured

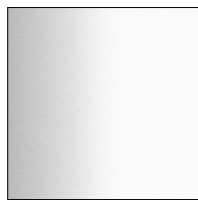

**WHE**  
White Textured

## Metallic



**CHM**  
Champagne



**SIM**  
Silver

## Premium



**AYE**  
Apricot  
Yellow  
Textured



**BRE**  
Brick Red  
Textured

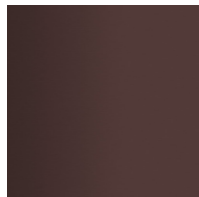

**CBE**  
Chocolate  
Brown  
Textured

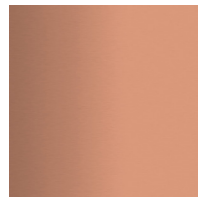

**CPE**  
Clay Pink  
Textured



**DBE**  
Dynamic Blue  
Textured



**GGE**  
Grass Green  
Textured



**HGE**  
Hunter Green  
Textured

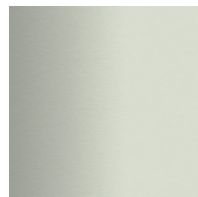

**LNE**  
Lunar Gray  
Textured



**NBE**  
Navy Blue  
Textured



**SBE**  
Sand Beige  
Textured



**SGE**  
Sage Gray  
Textured



**STE**  
Summer Teal  
Textured

# SEGMENT 74510

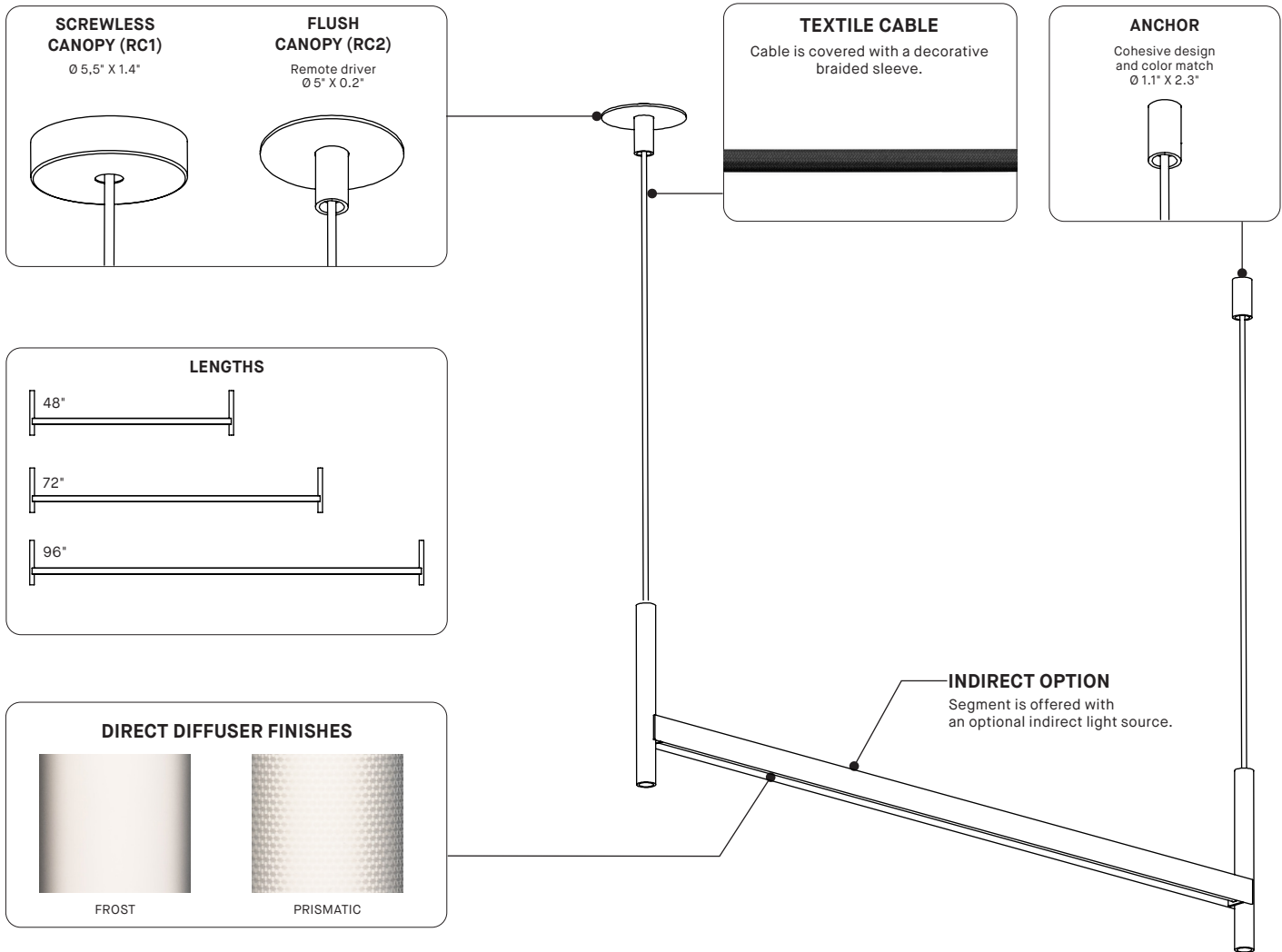

PRODUCT SPECIFICATION	48" DIRECT	72" DIRECT	96" DIRECT	48" INDIRECT	72" INDIRECT	96" INDIRECT
<b>PERFORMANCE</b>	<b>REG — HO</b>	<b>REG — HO</b>	<b>REG — HO</b>	<b>REG — HO</b>	<b>REG — HO</b>	<b>REG — HO</b>
SYSTEM WATTAGE	12 — 25 W	18 — 38 W	24 — 50 W	12 — 25 W	18 — 38 W	24 — 51 W
DELIVERED LUMENS (4000K)	1157 — 2307 LM	1735 — 3460 LM	2314 — 4615 LM	1469 — 2925 LM	2203 — 4384 LM	2937 — 5854 LM
DELIVERED LUMENS/FOOT (4000K)	289 — 577 LM/FT	289 — 577 LM/FT	289 — 577 LM/FT	367 — 731 LM/FT	367 — 731 LM/FT	367 — 731 LM/FT
EFFICACY	95 — 91 LM/W	94 — 90 LM/W	95 — 91 LM/W	120 — 115 LM/W	120 — 115 LM/W	120 — 115 LM/W
<b>OTHER INFORMATION</b>						
WEIGHT	~ 5.5 LBS / 2.5 KG	~ 7.2 LBS / 3.2 KG	~ 8.4 LBS / 3.8 KG			
L70 (LUMEN MAINTENANCE)	60,000 HRS	60,000 HRS	60,000 HRS	60,000 HRS	60,000 HRS	60,000 HRS

## EFFICACY MULTIPLIERS

CRI	CCT	FACTOR
90+	4000K	1.00
90+	3500K	0.98
90+	3000K	0.94
90+	2700K	0.91

## LIGHT DISTRIBUTION

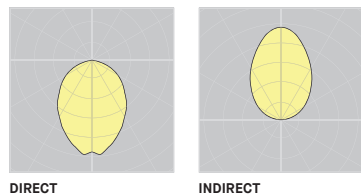

Visit our website for warranty terms and conditions.



## TECHNICAL DATA

# SEGMENT 74510

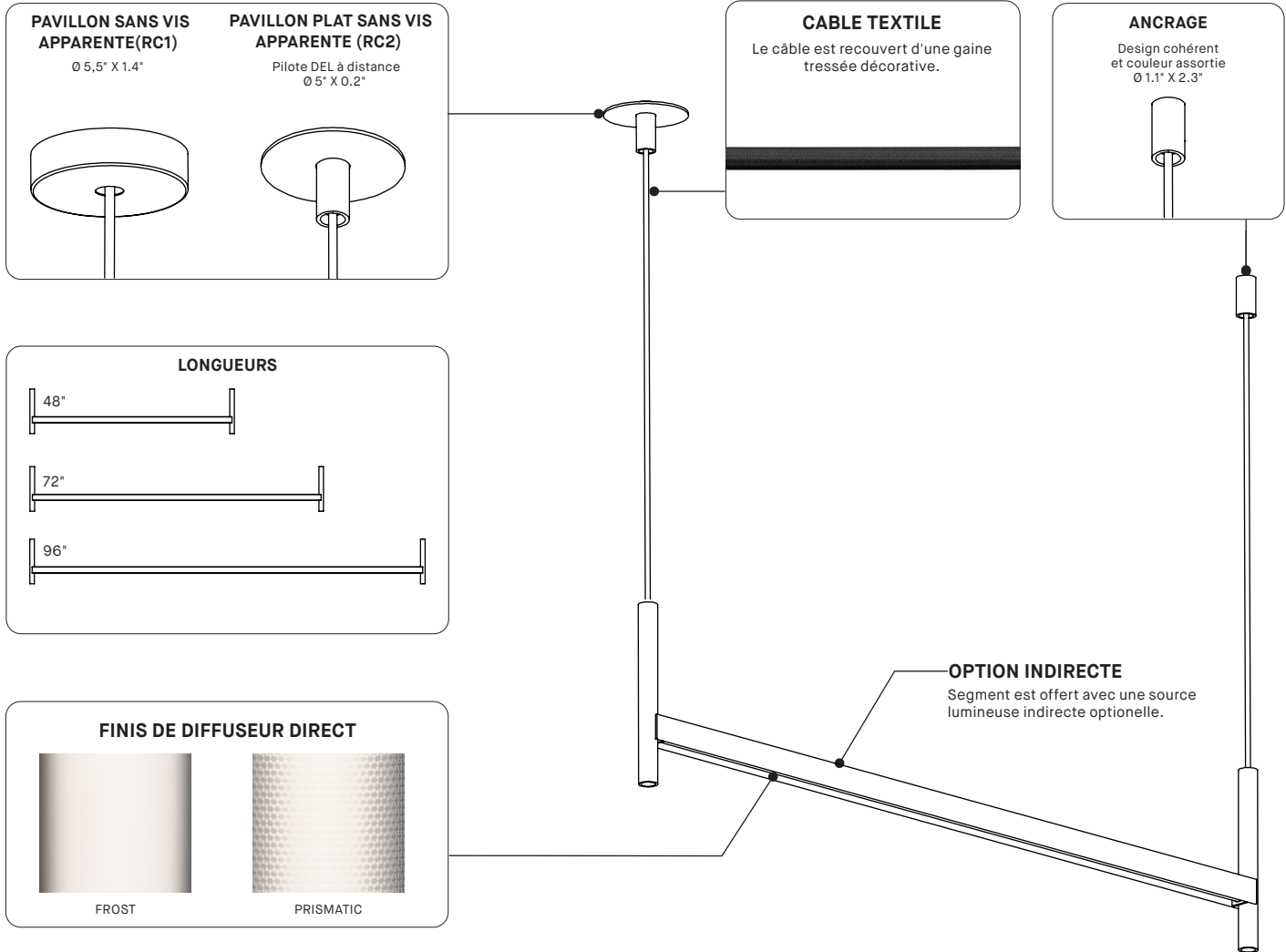

SPECIFICATIONS PRODUIT	48" DIRECT	72" DIRECT	96" DIRECT	48" INDIRECT	72" INDIRECT	96" INDIRECT
<b>PERFORMANCE</b>	<b>REG — HO</b>	<b>REG — HO</b>	<b>REG — HO</b>	<b>REG — HO</b>	<b>REG — HO</b>	<b>REG — HO</b>
<b>PUISSANCE TOTALE</b>	12 — 25 W	18 — 38 W	24 — 50 W	12 — 25 W	18 — 38 W	24 — 51 W
<b>LUMENS RÉELS (4000K)</b>	1157 — 2307 LM	1735 — 3460 LM	2314 — 4615 LM	1469 — 2925 LM	2203 — 4384 LM	2937 — 5854 LM
<b>LUMENS RÉELS PAR PIED (4000K)</b>	289 — 577 LM/PI	289 — 577 LM/PI	289 — 577 LM/PI	367 — 731 LM/PI	367 — 731 LM/PI	367 — 731 LM/PI
<b>EFFICACITÉ</b>	95 — 91 LM/W	94 — 90 LM/W	95 — 91 LM/W	120 — 115 LM/W	120 — 115 LM/W	120 — 115 LM/W
<b>OTHER INFORMATION</b>						
<b>POIDS</b>	~ 5,5 LBS / 2,5 KG	~ 7,2 LBS / 3,2 KG	~ 8,4 LBS / 3,8 KG			
<b>L70 (MAINTENANCE DE LA LUMIÈRE)</b>	60,000 HRS	60,000 HRS	60,000 HRS	60,000 HRS	60,000 HRS	60,000 HRS

## FACTEUR D'EFFICACITÉ

IRC	CCT	FACTEUR
90+	4000K	1.00
90+	3500K	0.98
90+	3000K	0.94
90+	2700K	0.91

## DISTRIBUTION LUMINEUSE

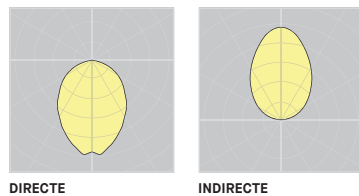

Visitez notre site Web pour les termes et conditions.

## SEGMENT 74510 - CANOPY COMPATIBILIY CHART

FIXTURE	CANOPY	
	RC1	RC2
	SCREWLESS CANOPY	REMOTE DRIVER OPTION SCREWLESS CANOPY
	0-10V + Phase dimming	0-10V dimming only
48" - D - REG	●	3981GC
48" - D - HO	●	3981GC
48" - DI - REG	●	3981GC
48" - DI - HO	●	3981GC
72" - D - REG	●	3981GC
72" - D - HO	●	3981GC
72" - DI - REG	●	3981GC
72" - DI - HO		3981GC
96" - D - REG	●	3981GC
96" - D - HO	●	3981GC
96" - DI - REG	●	3981GC
96" - DI - HO		3981GC